



An Introduction to HFSS



ANSYS, Inc.
Southpointe
2600 Ansys Drive
Canonsburg, PA 15317
ansysinfo@ansys.com
<https://www.ansys.com>
(T) 724-746-3304
(F) 724-514-9494

Release 2024 R2
July 2024

ANSYS, Inc. and ANSYS
Europe, Ltd. are UL registered
ISO 9001:2015 companies.

Copyright and Trademark Information

© 1986-2024 ANSYS, Inc. Unauthorized use, distribution or duplication is prohibited.

ANSYS, Ansys Workbench, AUTODYN, CFX, FLUENT and any and all ANSYS, Inc. brand, product, service and feature names, logos and slogans are registered trademarks or trademarks of ANSYS, Inc. or its subsidiaries located in the United States or other countries. Icem CFD is a trademark used by ANSYS, Inc. under license. All other brand, product, service and feature names or trademarks are the property of their respective owners. FLEXlm and FLEXnet are trademarks of Flexera Software LLC.

Disclaimer Notice

THIS ANSYS SOFTWARE PRODUCT AND PROGRAM DOCUMENTATION INCLUDE TRADE SECRETS AND ARE CONFIDENTIAL AND PROPRIETARY PRODUCTS OF ANSYS, INC., ITS SUBSIDIARIES, OR LICENSORS. The software products and documentation are furnished by ANSYS, Inc., its subsidiaries, or affiliates under a software license agreement that contains provisions concerning non-disclosure, copying, length and nature of use, compliance with exporting laws, warranties, disclaimers, limitations of liability, and remedies, and other provisions. The software products and documentation may be used, disclosed, transferred, or copied only in accordance with the terms and conditions of that software license agreement.

ANSYS, Inc. and ANSYS Europe, Ltd. are UL registered ISO 9001: 2015 companies.

U.S. Government Rights

For U.S. Government users, except as specifically granted by the ANSYS, Inc. software license agreement, the use, duplication, or disclosure by the United States Government is subject to restrictions stated in the ANSYS, Inc. software license agreement and FAR 12.212 (for non-DOD licenses).

Third-Party Software

See the legal information in the product help files for the complete Legal Notice for Ansys proprietary software and third-party software. If you are unable to access the Legal Notice, please contact ANSYS, Inc.

Conventions Used in this Guide

Please take a moment to review how instructions and other useful information are presented in this documentation.

- Procedures are presented as numbered lists. A single bullet indicates that the procedure has only one step.
- Bold type is used for the following:
 - Keyboard entries that should be typed in their entirety exactly as shown. For example, “**copy file1**” means you must type the word **copy**, then type a space, and then type **file1**.
 - On-screen prompts and messages, names of options and text boxes, and menu commands. Menu commands are often separated by greater than signs (>). For example, “click **HFSS > Excitations > Assign > Wave Port.**”
 - Labeled keys on the computer keyboard. For example, “Press **Enter**” means to press the key labeled **Enter**.
- Italic type is used for the following:
 - Emphasis.
 - The titles of publications.
 - Keyboard entries when a name or a variable must be typed in place of the words in italics. For example, “**copy filename**” means you must type the word **copy**, then type a space, and then type the name of the file.
- The plus sign (+) is used between keyboard keys to indicate that you should press the keys at the same time. For example, “Press Shift+F1” means to press the **Shift** key and, while holding it down, press the **F1** key also. You should always depress the modifier key or keys first (for example, Shift, Ctrl, Alt, or Ctrl+Shift), continue to hold it/them down, and then press the last key in the instruction.

Accessing Commands: *Ribbons*, *menu bars*, and *shortcut menus* are three methods that can be used to see what commands are available in the application.

- The *Ribbon* occupies the rectangular area at the top of the application window and contains multiple tabs. Each tab has relevant commands that are organized, grouped, and labeled. An example of a typical user interaction is as follows:

"Click **Draw > Line**"



This instruction means that you should click the **Line** command on the **Draw** ribbon tab. An image of the command icon, or a partial view of the ribbon, is often included with the instruction.

- The *menu bar* (located above the ribbon) is a group of the main commands of an application arranged by category such File, Edit, View, Project, etc. An example of a typical user interaction is as follows:

"On the **File** menu, click the **Open Examples** command" means you can click the **File** menu and then click **Open Examples** to launch the dialog box.

- Another alternative is to use the *shortcut menu* that appears when you click the right-mouse button. An example of a typical user interaction is as follows:

"Right-click and select **Assign Excitation> Wave Port**" means when you click the right-mouse button with an object face selected, you can execute the excitation commands from the shortcut menu (and the corresponding sub-menus).

Getting Help: Ansys Technical Support

For information about Ansys Technical Support, go to the Ansys corporate Support website, <http://www.ansys.com/Support>. You can also contact your Ansys account manager in order to obtain this information.

All Ansys software files are ASCII text and can be sent conveniently by e-mail. When reporting difficulties, it is extremely helpful to include very specific information about what steps were taken or what stages the simulation reached, including software files as applicable. This allows more rapid and effective debugging.

Help Menu

To access help from the Help menu, click **Help** and select from the menu:

- **[product name] Help** - opens the contents of the help. This help includes the help for the product and its *Getting Started Guides*.
- **[product name] Scripting Help** - opens the contents of the *Scripting Guide*.
- **[product name] Getting Started Guides** - opens a topic that contains links to Getting Started Guides in the help system.

Context-Sensitive Help

To access help from the user interface, press **F1**. The help specific to the active product (design type) opens.

You can press **F1** while the cursor is pointing at a menu command or while a particular dialog box or dialog box tab is open. In this case, the help page associated with the command or open dialog box is displayed automatically.

Table of Contents

Table of Contents	Contents-1
1 - Fundamentals of HFSS	1-1
Overview of High Frequency Structure Simulator (HFSS)	1-2
Mathematical Method Used in HFSS	1-4
Adaptive Solution Process and its Importance to HFSS	1-8
Computational Volume and its Parts	1-11
Solution Types	1-12
Solution Type Options	1-13
HFSS Simulation Examples	1-14
Network Analysis and Composite Excitations	1-16
2 - HFSS Boundaries	2-1
The Purpose of Boundaries in HFSS	2-1
The Different Boundary Conditions in HFSS	2-4
Anisotropic Impedance	2-6
Finite Conductivity	2-9
Impedance	2-10
Layered Impedance	2-10
Lumped RLC	2-11
Primary/Secondary (Lattice Pair)	2-13
Perfect Electric Conductor	2-14
Perfect H	2-15
Radiation Boundary	2-16
Symmetry	2-17
Perfectly Matched Layer (PML)	2-19
How to Apply Boundary Conditions	2-20
Auto-Open Region	2-22

Create Open Region	2-23
3 - HFSS Excitations	3-1
Excitations in HFSS	3-1
Wave Ports	3-2
Wave Ports for Terminal Solutions	3-4
Lumped Ports	3-5
Difference between Lumped Ports and Wave Ports	3-8
Floquet Ports	3-9
Incident Waves	3-10
Linked Fields	3-10
4 - HFSS Solution Setup	4-1
Driven Solution Setup	4-1
General Tab	4-5
Solution Frequency Setting for Advanced Setups	4-5
Adaptive Solutions	4-6
Options Tab	4-7
Initial Mesh Options	4-8
Lambda Refinement	4-8
Use Free Space Lambda	4-8
Adaptive Options	4-8
Advanced Solution Setup Options	4-8
Advanced Tab	4-9
Initial Mesh Options (Advanced)	4-9
Port Options	4-9
IE Solver Options	4-9
Fields	4-10
Expression Cache Tab	4-10
Defaults Tab	4-10

Transient Solution Setup	4-10
Transient Solver	4-11
Input Signal	4-12
Duration	4-13
Save Fields	4-13
Radiated Fields	4-13
HPC and Analysis Options	4-13
Domain Decomposition	4-14
The Maximum Number of Passes and Maximum Refinement Per Pass	4-15
Frequency Sweeps	4-16
Differences between Local, Remote and DSO solutions	4-19
5 - HFSS Modeling GUI Basics	5-1
The HFSS 3D Modeling GUI	5-1
3D Modeler Window	5-3
Properties Window	5-3
Project Manager Window	5-4
History Tree	5-4
Message window	5-4
Progress window	5-4
Modeling Practice in HFSS	5-4
1. Create Geometry	5-5
2. Assign Boundaries	5-5
3. Assign Excitations	5-6
4. Assign Solution Setup	5-6
5. Validate and Analyze	5-6
6. Post Processing	5-6
The Various Hotkeys	5-6
General Hotkeys	5-8

3D Modeler Hotkeys	5-9
Snapping to a Point	5-10
Assigning Boundaries in the GUI	5-11
Assigning Driven Modal Solution Excitations in the GUI	5-13
Assigning Driven Terminal Solution Excitations in the GUI	5-14
Assigning and Creating Materials	5-16
Creating Variables	5-19
6 - HFSS Post-Processing	6-1
Plotting S-parameter results	6-1
Exporting Touchstone Files	6-3
Advanced Plotting of Results	6-5
Plotting Antenna Results	6-6
Plotting Field Results	6-8
Creating Animations	6-10
7 - Component Modeling	7-1
3D Components	7-1
3D Components Workflow	7-1

1 - Fundamentals of HFSS

- ["Overview of High Frequency Structure Simulator \(HFSS\)" on the next page](#)
- ["Mathematical Method Used in HFSS" on page 1-4](#)
- ["Adaptive Solution Process and its Importance to HFSS" on page 1-8](#)
- ["Computational Volume and its Parts" on page 1-11](#)
- ["Solution Types" on page 1-12](#)
- ["Network Analysis and Composite Excitations" on page 1-16](#)

Overview of High Frequency Structure Simulator (HFSS)

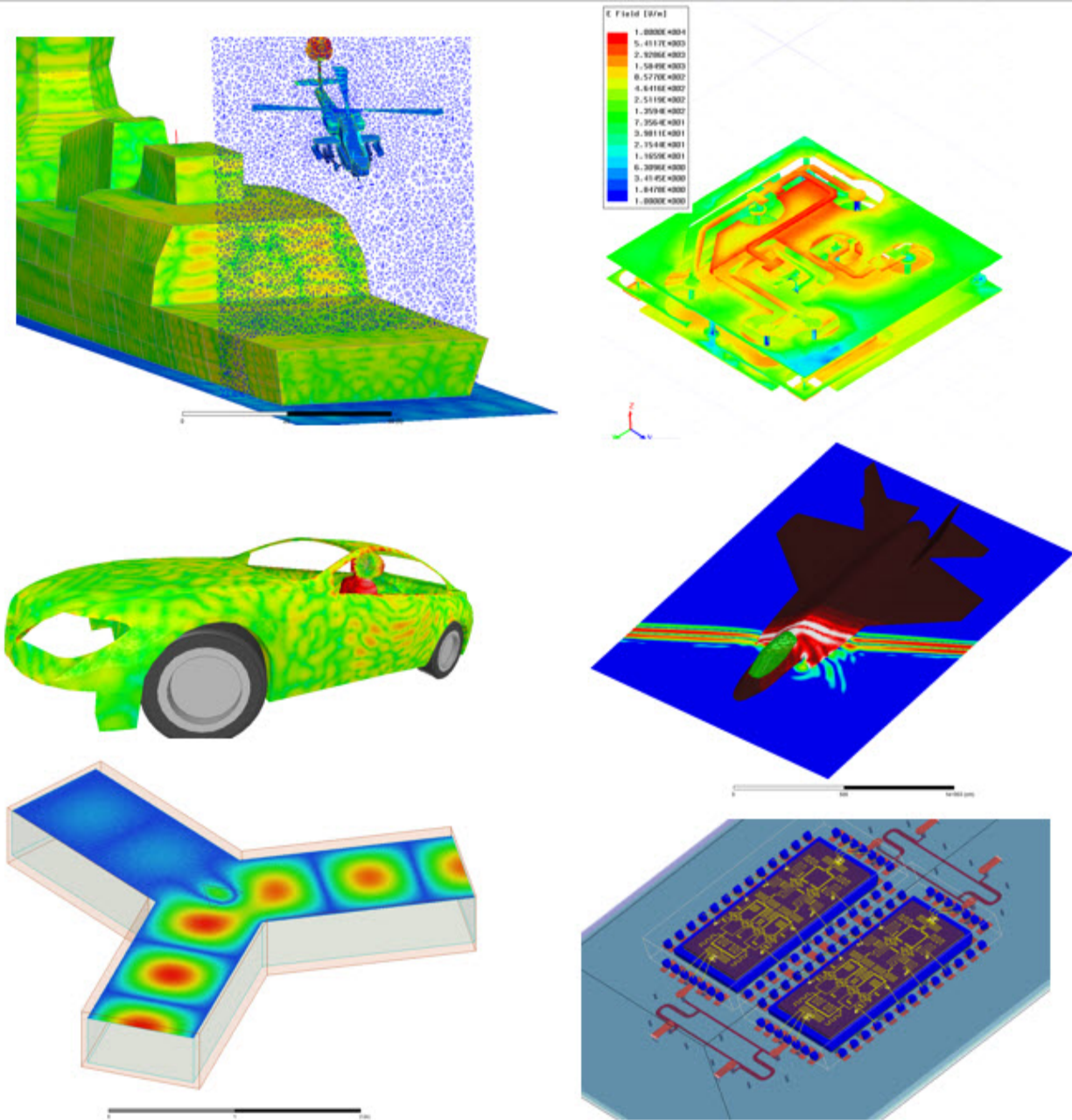

Figure 1-1 HFSS Designs and Electric Field Plots

High Frequency Structure Simulator (HFSS) is a 3D electromagnetic (EM) simulation tool used to design a broad range of high frequency products such as antennas, filters, and IC packages. HFSS has advanced 3D electromagnetic field solvers based on finite elements and other integral equation methods supported by high performance computing technology that enable engineers to perform rapid and accurate design of high-frequency and high speed electronic components.

The following figure contains results showing electric field plots on some sample designs created and solved in HFSS. These designs include:

- coaxial resonator model using Eigenmode solver
- driven terminal design of a complex package
- driven modal design of a coax-fed helical antenna with a dielectric support on a finite ground plane
- a waveguide combiner used to combine output power of two 20 GHz solid state power amplifiers

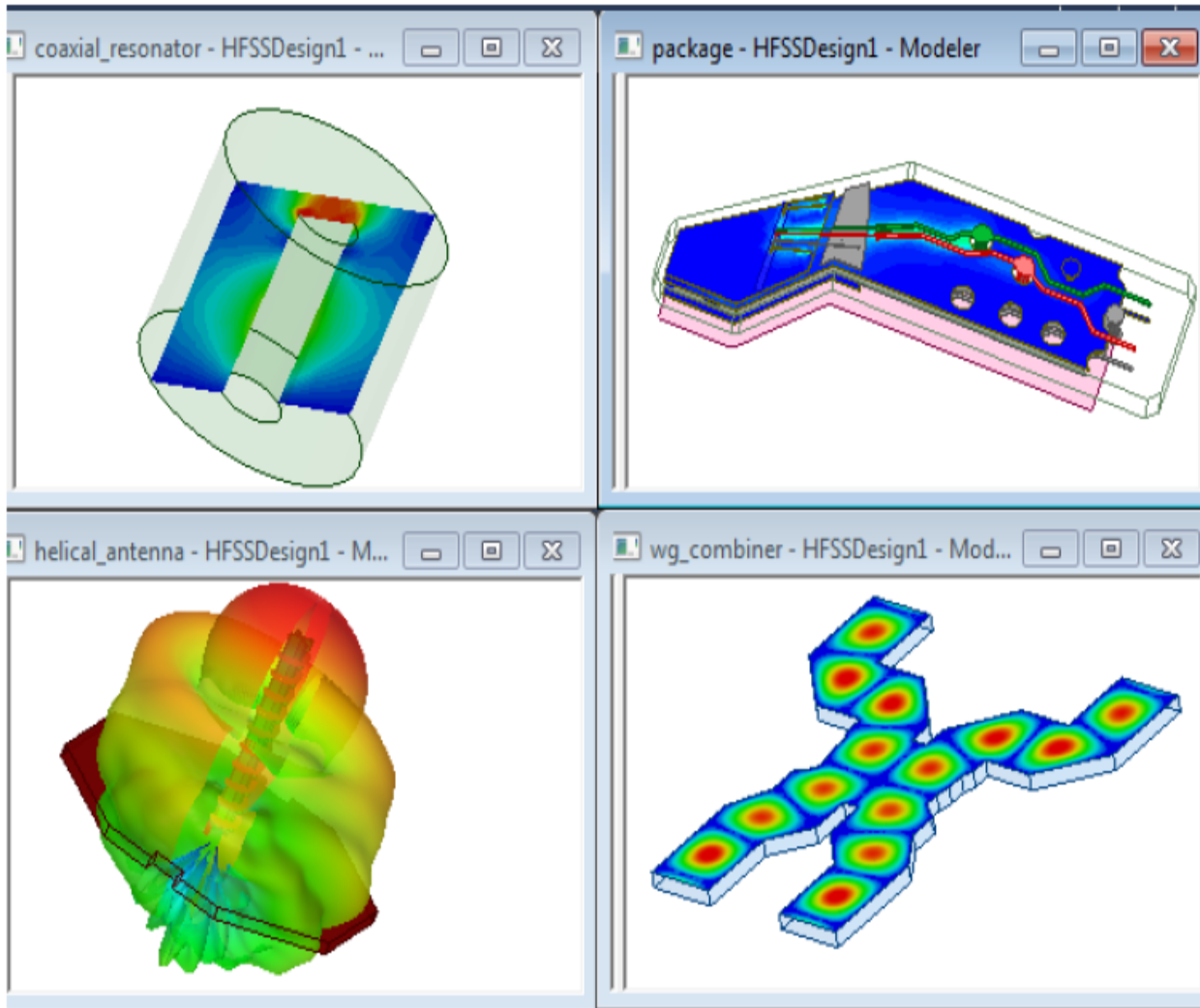

Figure 1-2 Sample HFSS designs with results

Mathematical Method Used in HFSS

The numerical technique used in HFSS™ is the Finite Element Method (FEM). In this method a structure is subdivided into many small subsections called finite elements. In HFSS these finite elements are in the form of tetrahedra. The entire collection of tetrahedra constitutes the finite element mesh. A solution is found for the fields within these tetrahedra. These fields are interrelated so that Maxwell's Equations are satisfied across inter-element boundaries yielding a field solution for the entire original structure. Once the field solution is found, the generalized S-matrix solution is determined. The following figure shows the geometry, mesh, field results, and the S-matrix results of a bandpass cavity filter in HFSS.

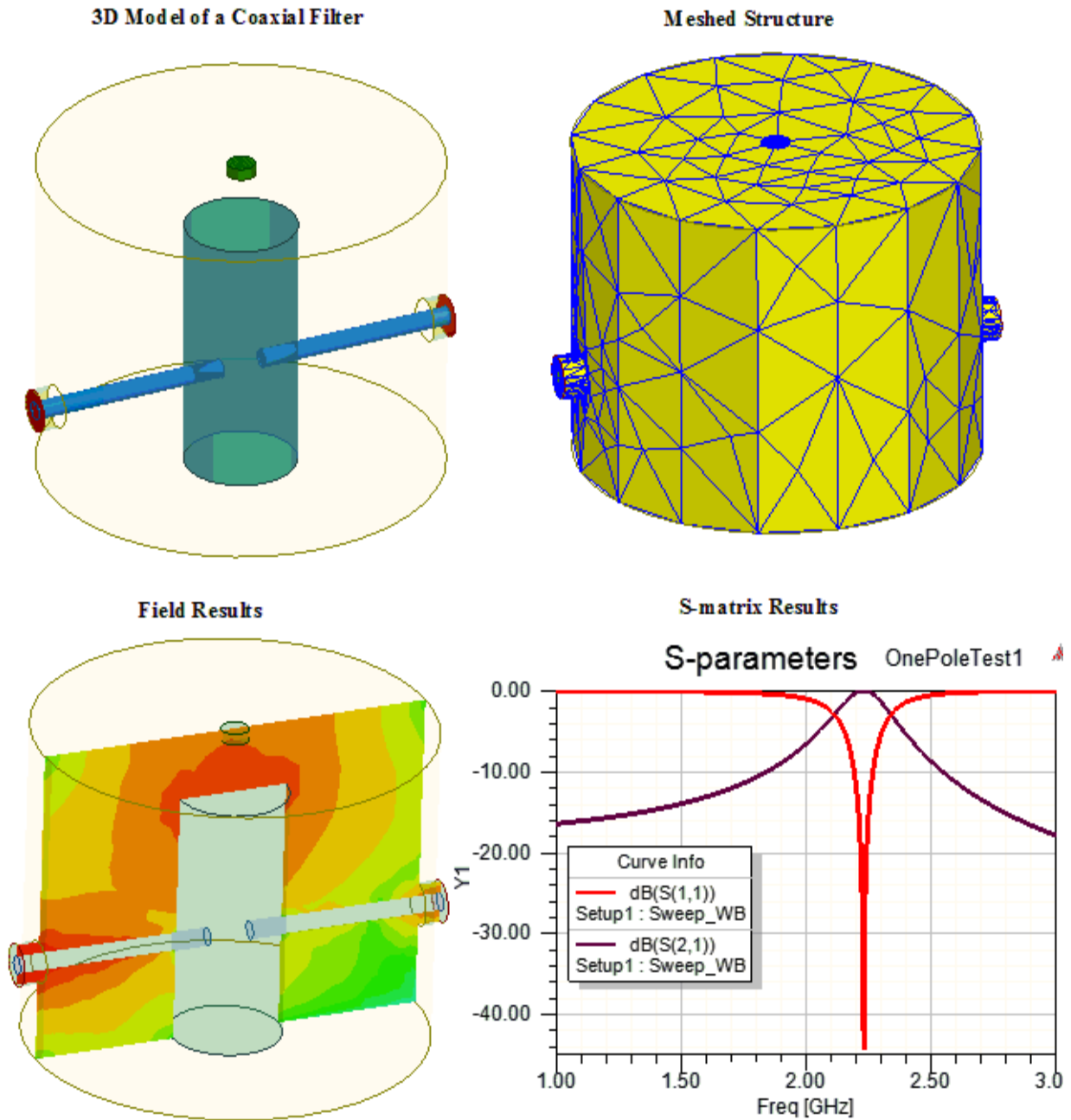

Figure 1-3 A sample HFSS model with mesh plot and results

Subject to excitation and boundary conditions, HFSS solves for the electric field \mathbf{E} using the following equation:

$$\nabla \times \left(\frac{1}{\mu_r} \nabla \times \mathbf{E} \right) - k_0^2 \epsilon_r \mathbf{E} = -j\omega \mu_0 \vec{\mathbf{J}}_{source} \quad (1)$$

where

$$k_0^2 = \frac{\omega^2}{c^2}$$

ϵ_r, μ_r are the relative permittivity and permeability respectively and c is the speed of light in vacuum.

Note $\vec{\mathbf{J}}_{source}$ is used to represent any source.

HFSS calculates the magnetic field \mathbf{H} using the following equation:

$$\mathbf{H} = \frac{j}{\omega\mu} \nabla \times \mathbf{E} \quad (2)$$

The remaining electromagnetic quantities are derived using the constitutive relations.

From the quantities used in equations (1) and (2) it's clear that a problem in HFSS is considered in terms of electric and magnetic fields rather than in terms of voltages and currents.

Consequently, it is important that an HFSS simulation includes a volume within which electric and magnetic fields exist. These volumes generally comprise of dielectrics and conductors (including air, that surround the conductors).

HFSS derives a finite element matrix using the field equations to calculate the fields and S-matrix associated with a structure excited with ports.

The procedure to solve the problem in HFSS can be briefly described as follows:

1. A geometric structure is represented by a finite element mesh using tetrahedral elements.
2. Testing functions W_n are defined for each tetrahedron, resulting in thousands of basis functions.
3. The field equation is multiplied by W_n and integrated over the solution volume

This procedure yields thousands of equations for $n=1,2,\dots,N$.

$$\int \left(W_n \cdot \nabla \times \left(\frac{1}{\mu_r} \nabla \times \mathbf{E} \right) - k_0^2 \epsilon_r W_n \cdot \mathbf{E} \right) dV = 0 \quad (3)$$

After manipulating these N equations and using Green's theorem and the divergence theorem the following equation is obtained:

$$\int_V \left[(\nabla \times W_n) \cdot \left(\frac{1}{\mu_r} \nabla \times \mathbf{E} \right) - k_0^2 \epsilon_r W_n \cdot \mathbf{E} \right] dV = \int_S \text{boundary terms} dS \quad (3a)$$

for $n=1,2,\dots,N$ writing,

$$\mathbf{E} = \sum_m x_m \mathbf{W}_n, \quad n = 1, 2, \dots, M \quad (4)$$

rewrites (3a) as,

$$\sum_m x_m \int \left[(\nabla \times \mathbf{W}_n) \cdot \left(\frac{1}{\mu_r} \nabla \times \mathbf{W}_m \right) - k_0^2 \mathbf{W}_n \cdot \mathbf{W}_m \right] dV = \int_S \text{boundary terms} dS \quad (5)$$

for $n=1,2,\dots,N$

Equation (5) then has the form

$$\sum_m x_m A_{n,m} = b_n, \quad n = 1, 2, \dots, N \quad (6)$$

or

$$\mathbf{Ax} = \mathbf{b} \quad (7)$$

In this matrix equation, A is a known NxN matrix that includes any applied boundary condition terms, while b contains the port excitations, voltage and current sources and incident waves.

\mathbf{E} can be calculated when equation (7) is solved for x.

In HFSS the shape functions or testing functions W_n (appearing in the above equations) are vectors. They are curl conform which essentially means that the tangential continuity of the E field is maintained. They are also hierarchical with variable polynomial order. In other words the higher order polynomial shape functions are appended to the lower order polynomial shape functions. Different orders of basis functions employ different interpolation schemes for interpolating field values from the nodal values. This property is imperative for the iterative solver.

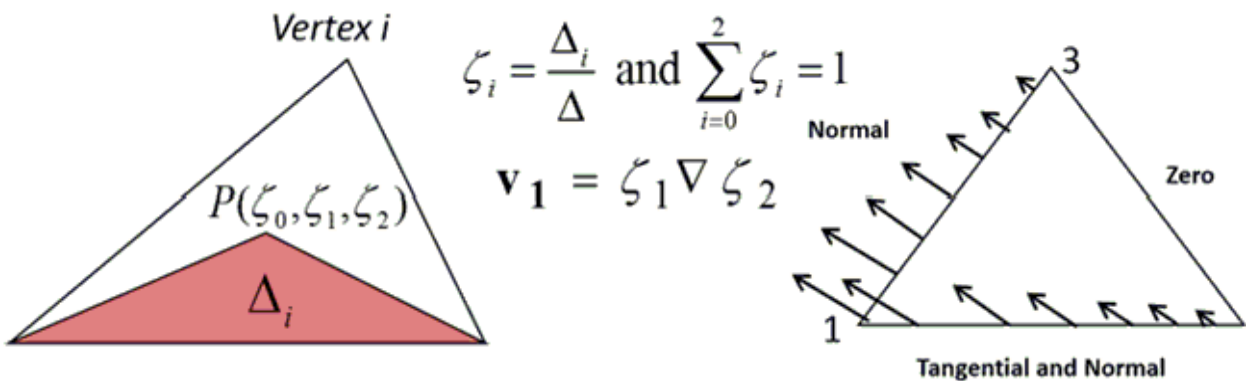

Figure 1-4 Hierarchical vector basis functions

The field solution process utilized by HFSS is iterative. In other words, HFSS uses the above process repeatedly by refining the mesh in an intelligent manner, until the correct field solution is found. This repetitive process is known as the adaptive mesh refinement process that yields highly accurate results.

For example, consider a simple waveguide structure. Initially, HFSS computes the modes on the cross-section of the waveguide. These modes serve as port excitations for the waveguide. HFSS uses a two dimensional FEM solver to calculate these modes. This initial calculation is referred to as the “port solution.” Once the port modes are known, they are used to specify the b matrix.

After the right hand side of equation 7 is determined, HFSS computes the full three-dimensional electromagnetic fields within the solution volume using the adaptive solution process. When the final fields are calculated, HFSS derives the generalized S- matrix for the entire model.

Note: The gamma results and characteristic wave impedance Z_0 that HFSS displays in a matrix data for a given simulation are essentially the transmission line properties of the modes of the wave port.

Adaptive Solution Process and its Importance to HFSS

HFSS uses the automatic adaptive mesh refinement process to solve an EM problem. Automatic adaptive mesh refinement is a critical part of the overall solution process and the key to producing accurate results. This meshing technique helps you focus on setting up your design efficiently rather than spending time in determining and creating the best mesh. To set up the design, you need only to create the geometry and specify material properties, boundary conditions, excitations, and the solution frequency.

Note: For more information about how to set up a design, see ["Modeling Practice in HFSS" on page 5-4](#).

In the adaptive mesh refinement process, the mesh is refined iteratively and is localized to regions where the electric field solution error is high. This iterative refinement technique increases the solution’s accuracy with each adaptive solution. The refinement process continues until HFSS converges to an accurate solution. Convergence is determined by monitoring a parameter from one adaptive pass to the next. The most common convergence criterion is to ensure that the difference in the S-parameter value between two consecutive solves is less than the specified magnitude.

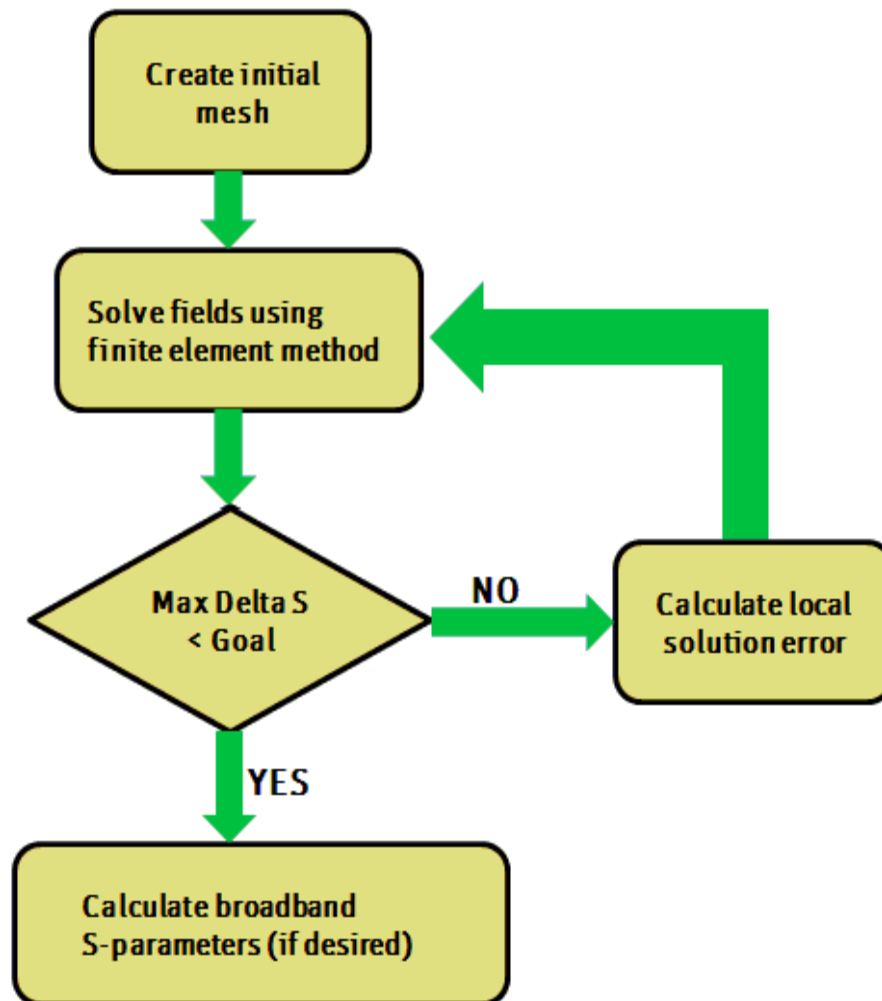

Figure 1-5 Simplified Flow Chart of Adaptive Refinement

The adaptive process can be summarized as follows:

1. HFSS generates an initial geometrically conformal mesh.
2. Using the initial mesh, HFSS computes the electromagnetic fields that exist inside the structure when it is excited at the solution frequency.
3. Based on the current finite element solution, HFSS determines the regions of the problem domain where the exact solution has a high degree of error. A predefined percentage of tetrahedra in these regions is refined. The mesh is refined by creating a number of smaller tetrahedra that replace the original larger element.
4. HFSS generates another solution using the refined mesh.
5. HFSS recomputes the error, and the iterative process (solve -> error analysis -> refine) occurs until the convergence criteria are satisfied or the requested number of adaptive passes is completed.

Note: If a frequency sweep is being performed, HFSS solves the problem at other frequency points without further refining the mesh.

The above process creates an appropriate mesh for any arbitrary HFSS simulation ensuring an accurate result for a given simulation.

Mathematically, the error is computed along the following lines.

Let \mathbf{E}^{approx} be the solution to step 2 above. This value is inserted in the following equation

$$\nabla \times \left(\frac{1}{\mu_r} \nabla \times \mathbf{E} \right) - k_0^2 \epsilon_r \mathbf{E} = 0 \quad (8)$$

yielding

$$\nabla \times \left(\frac{1}{\mu_r} \nabla \times \mathbf{E}^{approx} \right) - k_0^2 \epsilon_r \mathbf{E}^{approx} = residue \quad (9)$$

For each tetrahedron in the mesh, the residue function is evaluated. A percentage of the tetrahedra with high residue values are selected and refined.

The following figures illustrate the automated adaptive mesh refinement solution process that is used by HFSS for the simulation of a patch antenna.

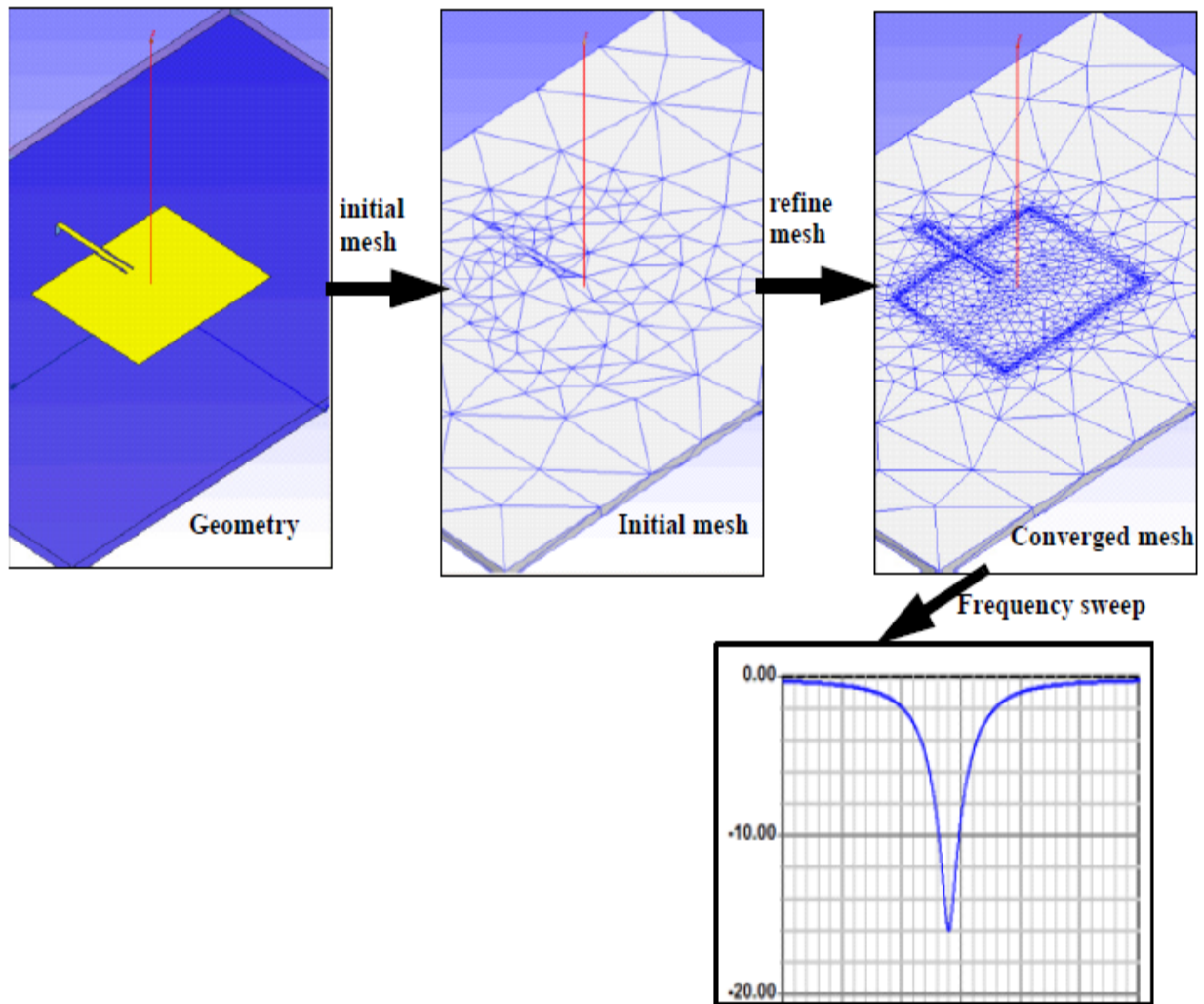

Figure 1-6 Adaptive mesh refinement example

Computational Volume and its Parts

A computational volume or solution space is the volume within which HFSS explicitly calculates the electromagnetic fields.

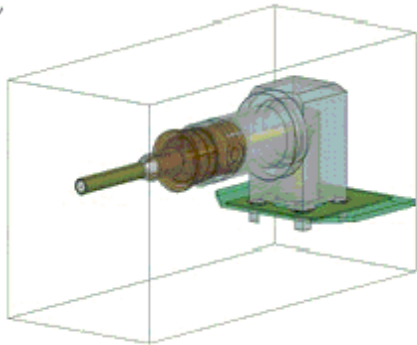

Figure 1-7 Computational volume containing a connector

A computational volume essentially consists of all the regions and objects inside which you want to determine the electromagnetic fields. The outermost surfaces of the computational volume are generally referred to as outer faces or outside boundaries. These faces are the outermost boundaries of the model, and HFSS explicitly calculates all fields within the solution space that these boundaries define. All field quantities that are calculated by HFSS outside the computational volume are derived from the fields within the solution space.

Solution Types

Before creating the design, you must specify the type of solution that you want HFSS to calculate. The following solution types are available:

- **HFSS:** The default solution type for HFSS designs.
- **HFSS with Hybrid and Arrays:** Adds the ability to define hybrid regions and arrays in the HFSS design.
- **Transient:** Used for calculating problems in the time domain. Transient solutions are applicable for simulations involving pulsed excitations (for example, lightning strikes).
- **SBR+:** Simplifies design creation for SBR+ users. HFSS can use Savant shooting and bouncing ray (SBR) technology to calculate the far field from current sources and defined geometry via one-way coupling. With this solution type, you do not need to specify explicit SBR+ Hybrid Regions.
- **Eigenmode:** This solution type provides results in terms of eigenmodes (or resonant frequencies) of a given structure. The solver provides the resonant frequencies as well as the fields at a particular resonant frequency.
- **Characteristic Mode:** This solution type is used for calculating the characteristic modes of a structure. The structure can be metal (conductor) or dielectric. The solution reports

the number of modes, the characteristic angle and current (amp/meter), the modal significance and quality factor, and the voltage per port based on edit source weightings.

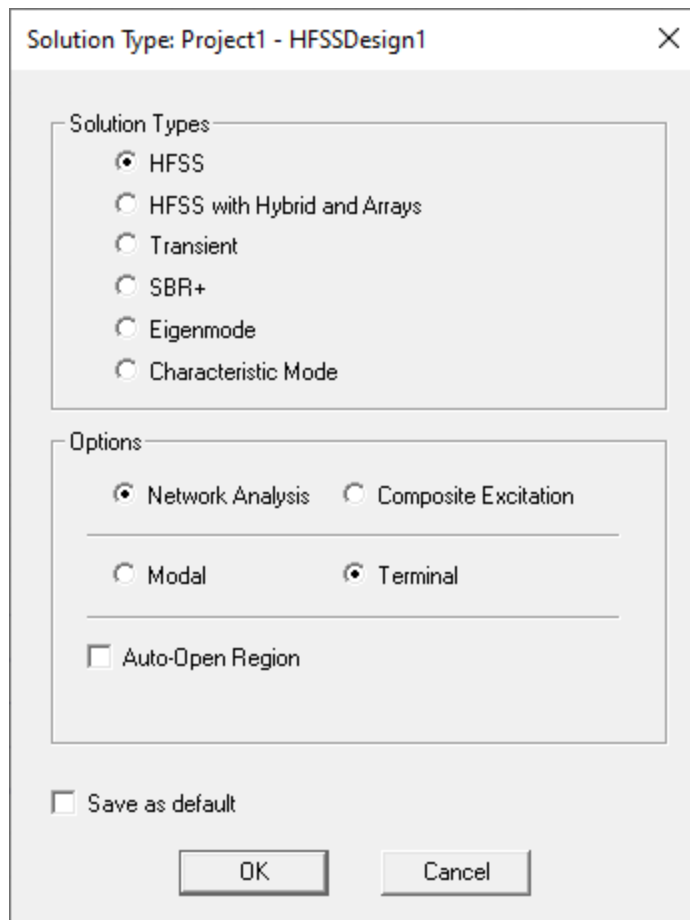

Figure 1-8 Solution Type Dialog Box for HFSS Designs

Solution Type Options

Three additional options are available for the **HFSS**, **HFSS with Hybrid and Array**, and **Transient** solution types only.

- Choose one of the following two options:
 - **Network Analysis:** The default solution option for applicable solution types.
 - **Composite Excitation:** This option provides a method for solving fields in a large frequency domain problem.
- **Auto-Open Region:** This option is typically used for antenna simulations. It automatically creates an open region and a predefined analysis setup for the project. You can select whether the region is Radiation, FE-BI, or PML. This option simplifies the design process.

If you do not choose *Auto-Open Region*, you must create an air box and then assign a radiation boundary, either manually, or using the *Create Open Region* command.

Two additional options are available for **HFSS** and **HFSS with Hybrid and Array** solution types only.

- Choose one of the following two options:
 - **Modal:** This option yields S-matrix solutions that are expressed in terms of the incident and reflected powers of transmission line modes.
 - **Terminal:** The default option for applicable solution types. This option yields S-matrix solutions that are expressed in terms of terminal voltages and currents. For simulations that deal with signal integrity, the *Terminal* solution option is preferred. Such problems generally include transmission lines with single wave or multiple conductors.

Modal Option versus Terminal Option:

If HFSS is used to model a pair of coplanar, parallel microstrip transmission lines, a driven modal solution yields results in terms of the even and odd modes that propagate on the structure, whereas a driven terminal mode solution generates the common and differential mode results.

HFSS Simulation Examples

The design below represents a terminal solution of a differential pair of vias. A pair of lines transition through circuit board vias to a pair of striplines on a lower layer. The two microstrip lines and the striplines are each assigned a terminal in the coupled microstrip port. The conductors are copper, and a radiation boundary is applied to the air box. The design was solved at 4.38 GHz, and the electric field plots on the surfaces of the wave ports with terminals are shown in the following figure:

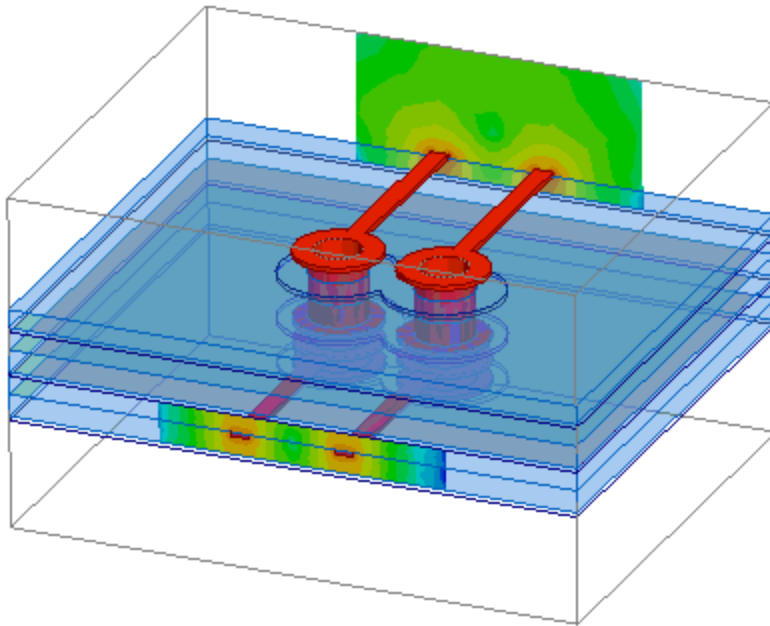

Figure 1-9 Terminal Solution of a Differential Pair of Vias

The following figure represents a modal solution of a connector between a coaxial and microstrip line:

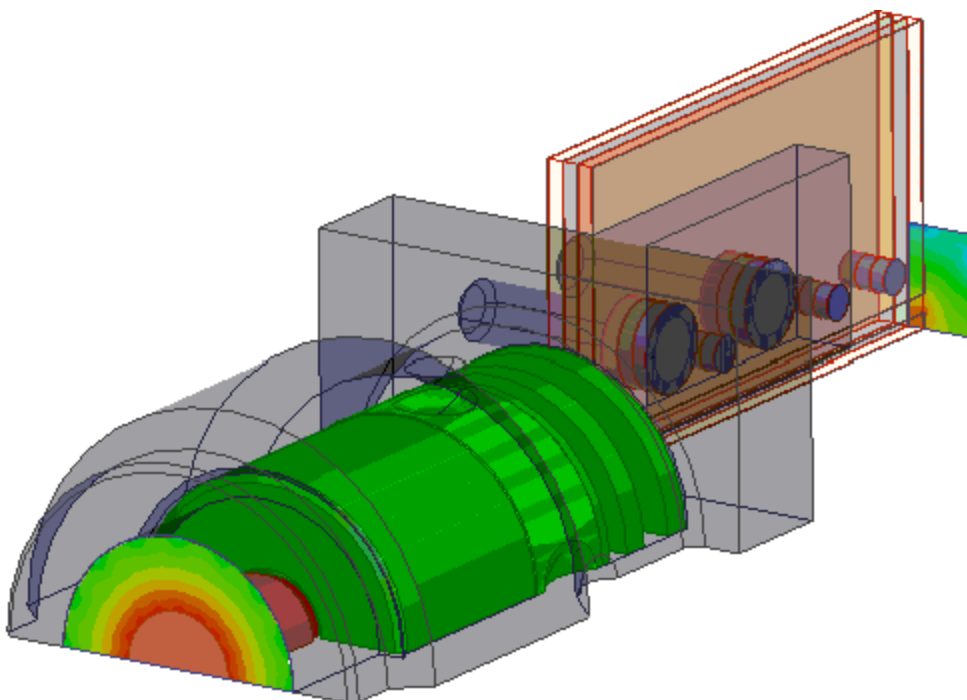

Figure 1-10 Connector between Coaxial and Microstrip Line

The following figure demonstrates a 3D finite element transient simulation of a lightning strike on a helicopter. Large currents flow through the aircraft skin generating electromagnetic field with the potential to damage sensitive equipment within. By using a transient simulation such challenges can be predicted early in the design phase saving costly empirical testing.

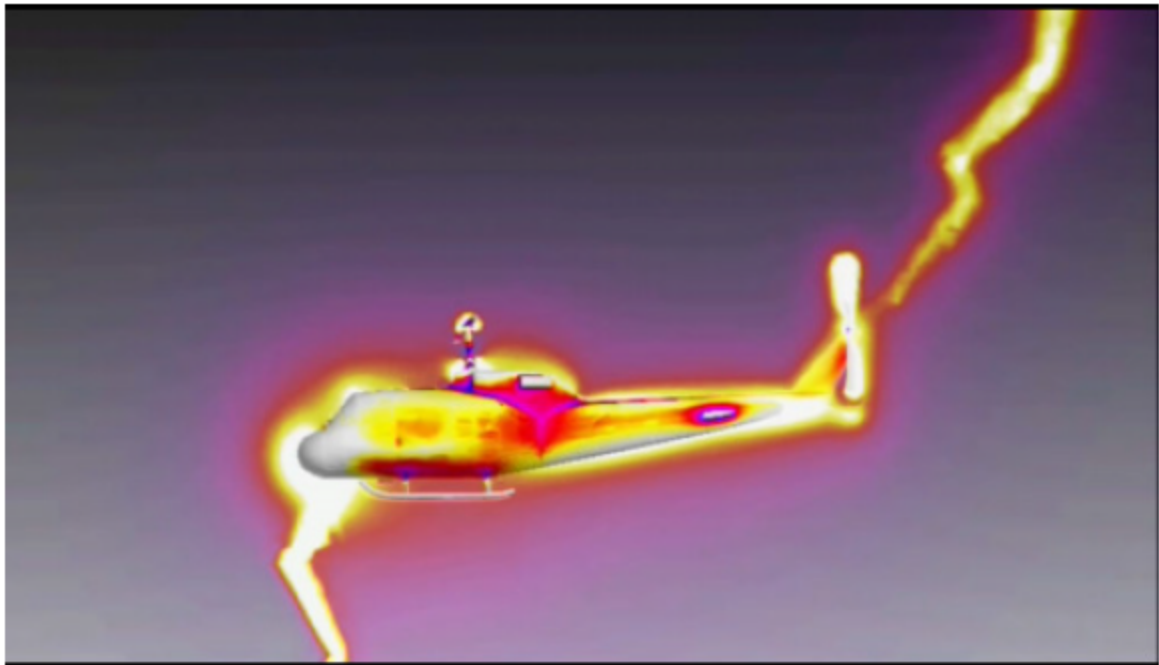

Figure 1-11 Lightning Strike Simulation of a Helicopter

Network Analysis and Composite Excitations

Network Analysis and Composite Excitations are used with driven modal, terminal, and transient problems. These options determine how HFSS applies excitations on a design during the adaptive refinement solution process.

When the **Network Analysis** option is selected, HFSS solves the design by exciting the ports individually and loading the remaining ports by matched characteristic impedances. Therefore, the number of solutions that HFSS calculates is equal to the number of ports on a design.

When the **Composite Excitations** option is selected, all the existing ports in a design are excited at the same time so HFSS needs to solve the design just once. The solution generated by Composite Excitations is much faster than Network Analysis.

2 - HFSS Boundaries

- ["The Purpose of Boundaries in HFSS" below](#)
- ["The Different Boundary Conditions in HFSS" on page 2-4](#)
- ["Anisotropic Impedance" on page 2-6](#)
- ["Finite Conductivity" on page 2-9](#)
- ["Impedance" on page 2-10](#)
- ["Layered Impedance" on page 2-10](#)
- ["Lumped RLC" on page 2-11](#)
- ["Primary/Secondary \(Lattice Pair\)" on page 2-13](#)
- ["Perfect Electric Conductor" on page 2-14](#)
- ["Perfect H" on page 2-15](#)
- ["Radiation Boundary" on page 2-16](#)
- ["Symmetry" on page 2-17](#)
- ["Perfectly Matched Layer \(PML\)" on page 2-19](#)
- ["How to Apply Boundary Conditions" on page 2-20](#)
- ["Auto-Open Region" on page 2-22](#)
- ["Create Open Region" on page 2-23](#)

The Purpose of Boundaries in HFSS

The purpose of using boundary conditions in HFSS is to define the behavior of the electromagnetic field on the object interfaces and at the edges of a problem region. Defining boundary conditions reduces the electromagnetic or geometric complexity of the model.

A closed model represents a structure or a solution volume where no energy escapes except through an applied port. For an Eigenmode simulation, this closed model represents a cavity resonator and for a driven modal or terminal solution, the model can be a waveguide or some other fully enclosed structure.

An electromagnetically open model allows energy to emanate or radiate away. Common examples include an antenna, a printed circuit board, or any structure that is not enclosed within a closed cavity.

By default HFSS treats any given model as closed since all outer surfaces of the solution space are covered with a perfect electric conducting boundary. In order to create an open model, you must specify a boundary on the outer surfaces that overwrites the default perfect electric conducting boundary.

Boundary conditions are assigned on 2D sheet objects and surfaces of 3D objects.

Every HFSS model that you create uses boundaries on the outer surfaces of the solution space. Depending upon the type of boundary specified any given HFSS model has a conducting, radiation, or a perfectly matched layer (PML) boundary condition on all outer surfaces. Conducting boundaries are the perfect electric conductor (PEC), finite conductivity, or impedance boundary.

Note: For more information about a complete list of boundary conditions see the section The Available Boundaries in HFSS.

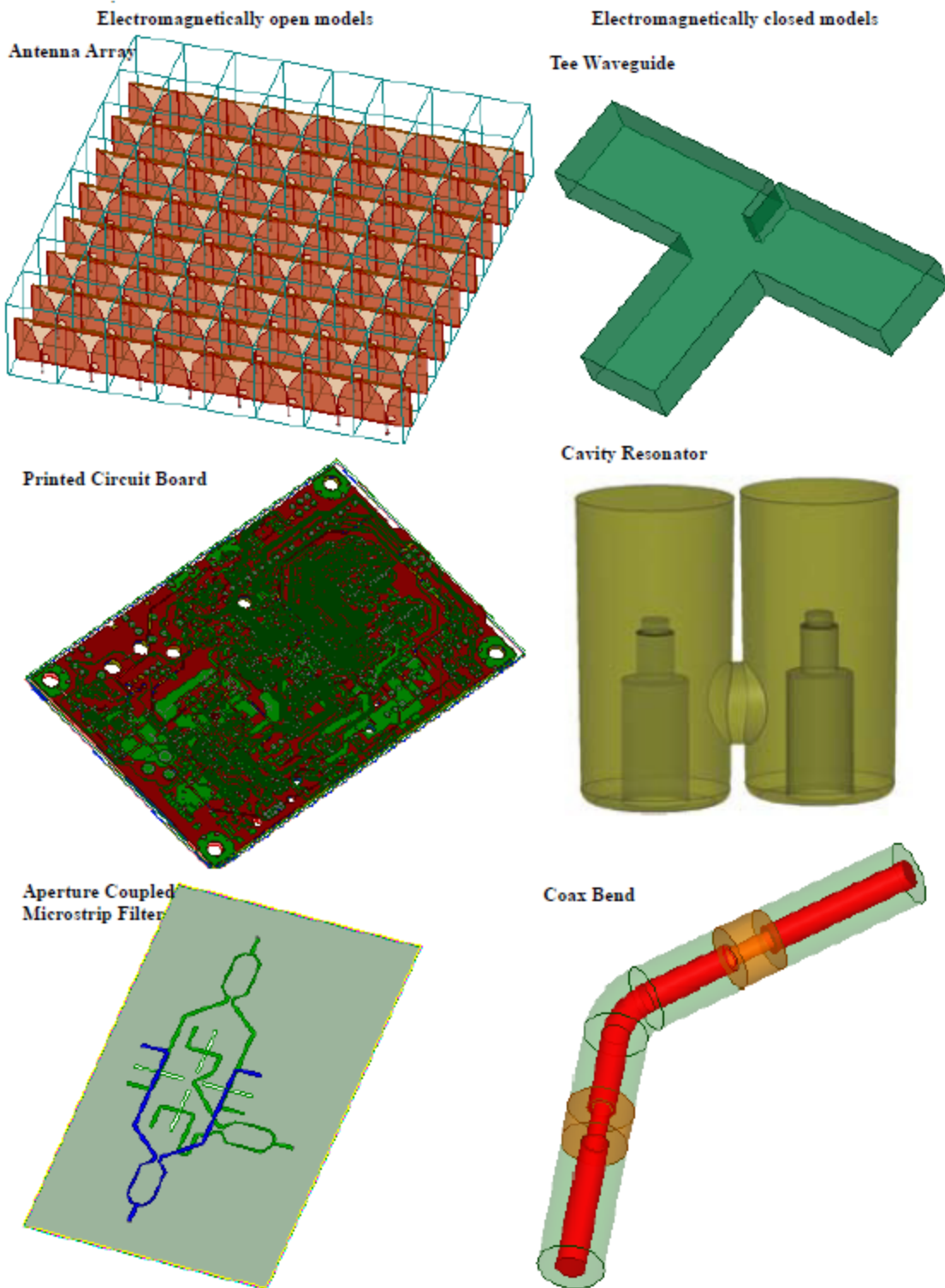

Figure 2-1 Sample HFSS electromagnetic structures

The Different Boundary Conditions in HFSS

Boundaries specify the behavior of magnetic and electric fields at various surfaces in the model.

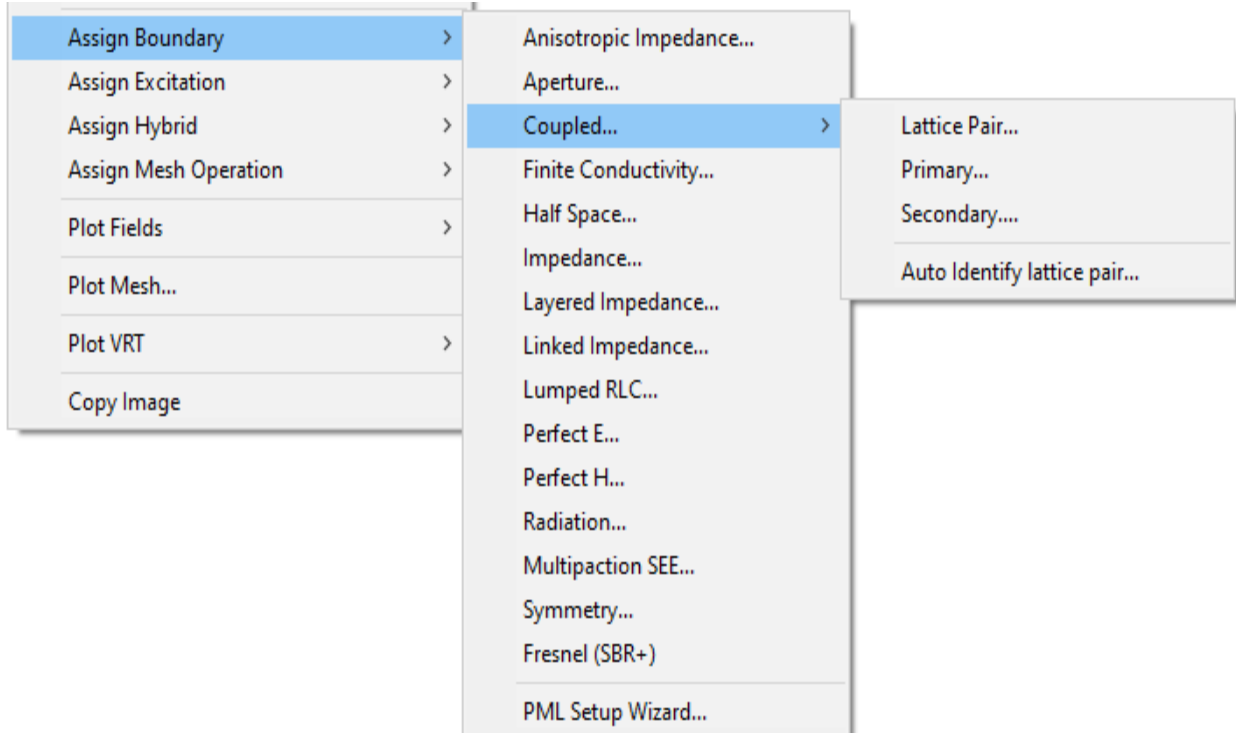

Figure 2-2 Available boundaries in HFSS

The following types of boundary conditions are available in HFSS:

Anisotropic Impedance

Anisotropic impedance boundary condition represents a sheet with different impedance values from different tangential directions taking the polarization of the incident field into account.

Aperture

Represents a hole in a metallic sheet assigned as an IE Region.

Finite Conductivity

Finite Conductivity boundary condition allows creation of single layer conductors. Finite conductivity boundaries represent imperfect conductors and is valid only if the conductor being modeled is a good conductor.

Fresnel (SBR+)

Represents either a perfect absorbing boundary or a user-defined Fresnel table file that describes a good approximation of the reflection of an arbitrary wavefront off a surface. Supported for driven modal/terminal and SBR+ solution types.

Half Space

Represents a background comprising a dielectric half space. For antenna and scattering problems in HFSS in which all objects are assigned as Hybrid IE Region.

Impedance

An impedance boundary condition represents a resistive surface; it allows creation of ohm per square material layers.

Lattice Pair

A Coupled pair, the same as one Primary Boundary and one Secondary Boundary together, but with an auto-set coordinate system. A red arrow points from the primary to the secondary face of the Lattice Pair.

Layered Impedance

Layered impedance boundary is used to model multi-layered conductors and thin dielectrics.

Linked Impedance

Represents a data link to an isotropic or anisotropic impedance boundary in another design. These can include infinite ground planes and shell elements.

Lumped RLC

Lumped RLC allows creation of ideal circuit components. It represents any combination of lumped resistor, inductor, and/or capacitor in parallel on a surface.

Multipaction SEE

For Multipaction Analysis, this represents multipaction Secondary Electron Emission (SEE). The Multipaction SEE boundaries should be added to vacuum-material interfaces where secondary electrons will be generated.

Perfect E

Represents a perfectly conducting surface.

Primary

Primary represents a surface on which the E-field at each point is matched to another surface (the Secondary boundary) within a phase difference. It's used with secondary boundary to model infinitely large repeating array structures.

Perfect H

Perfect H represents a surface where the tangential component of H is zero.

PML

Represents an open boundary condition using several layers of specialized materials that absorb outgoing waves. A PML is used to create an open boundary condition using several layers of specialized materials for absorbing outgoing waves. PML boundary conditions are preferred for antenna simulations.

Radiation

A radiation boundary is used to create an open model. It represents an open boundary by way of an absorbing boundary condition ABC that absorbs outgoing waves.

Secondary

Secondary represents a surface on which the E-field at each point has been forced to match the E-field of another surface (the primary boundary) within a phase difference. It's used with primary boundary to model large infinitely repeating array structures.

Symmetry

Symmetry boundary represents a perfect E or perfect H plane of symmetry.

A PML is used to create an open boundary condition using several layers of specialized materials for absorbing outgoing waves. PML boundary conditions are preferred for antenna simulations.

All these different types of boundary conditions are discussed in detail in the following sections.

Anisotropic Impedance

Anisotropic impedance boundary is a special impedance boundary which can be applied when the relationship between the electric field and magnetic field depends upon the direction. The relationship has to be defined in two orthogonal directions which form the main axes x and y.

$$E_x = Z_{xx}(\mathbf{n} \times \mathbf{H})_x + Z_{xy}(\mathbf{n} \times \mathbf{H})_y \quad E_y = Z_{yx}(\mathbf{n} \times \mathbf{H})_x + Z_{yy}(\mathbf{n} \times \mathbf{H})_y$$

This boundary condition is described by a 2 by 2 matrix as shown below:

$$Z = \begin{bmatrix} Z_{xx} & Z_{xy} \\ Z_{yx} & Z_{yy} \end{bmatrix}$$

The example shown below demonstrates the anisotropic impedance boundary condition. The following Z matrix was applied for a parallel plate waveguide with different E field polarizations.

$$Z = \begin{bmatrix} 0.01 & 0 \\ 0 & 1000 \end{bmatrix} \text{ohms}$$

In effect this Z matrix represents a short circuit for E field polarization along the x direction and open circuit for E field polarization along the y direction. This is illustrated in the following figures.

Z matrix can be expressed in analytical form or can be imported from another external design. This is called the screening impedance boundary condition. The external design is usually a unit cell model of a periodic structure, which shows different electromagnetic behavior in different directions.

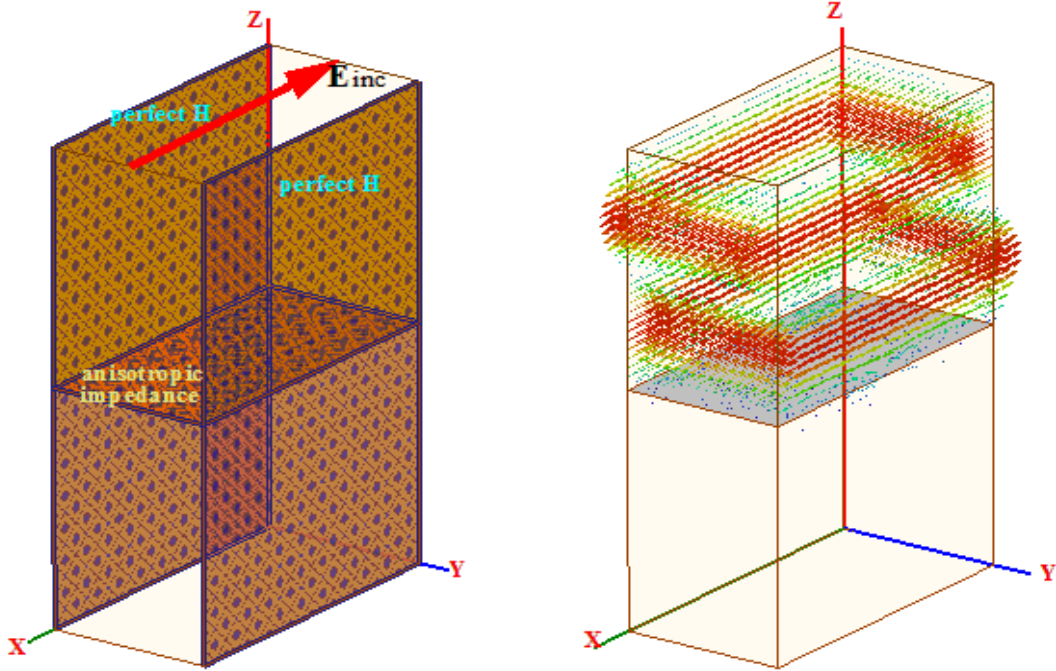

$$Z = \begin{bmatrix} 0.01 & 0 \\ 0 & 1000 \end{bmatrix} \text{ ohms}$$

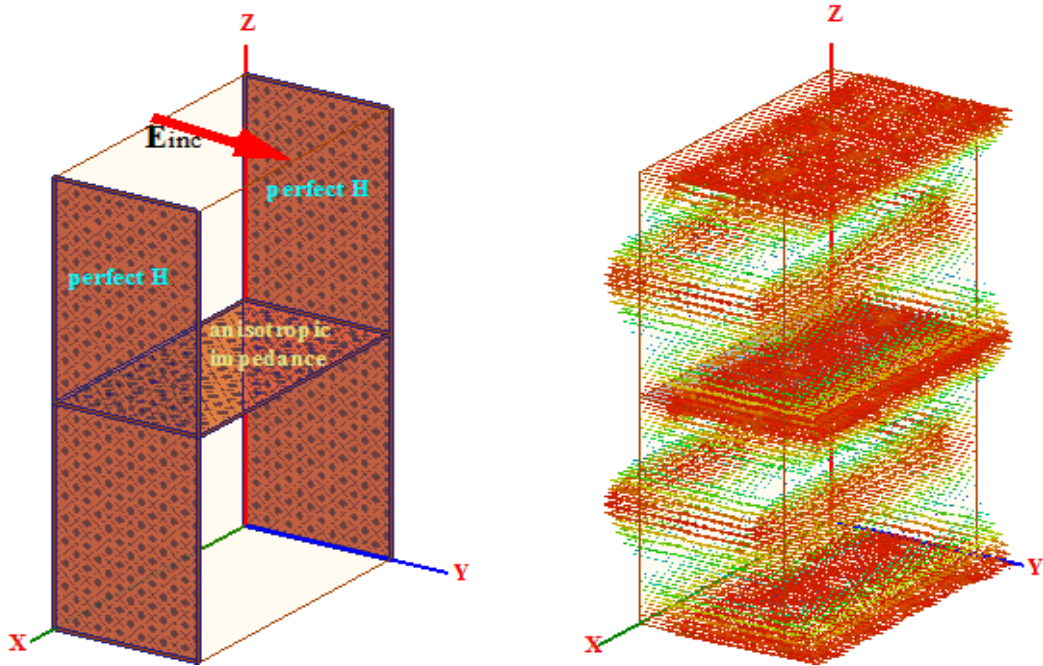

Figure 2-3 Parallel plate waveguide showing the effects of assigning anisotropic impedance

Finite Conductivity

The Finite Conductivity boundary is used to model conductors as 2D sheet objects. This boundary condition is used when modeling planar antennas or traces on a PCB where the thicknesses are very small but larger than the skin depth. Finite conductivity boundary condition efficiently models signal traces, ground planes, or a radiating element. The following figure illustrates a microstrip filter with apertures. Since the thickness of the trace and the ground plane is small but larger than the skin depth they can be replaced by sheet objects with finite conductivity boundary conditions assigned to them.

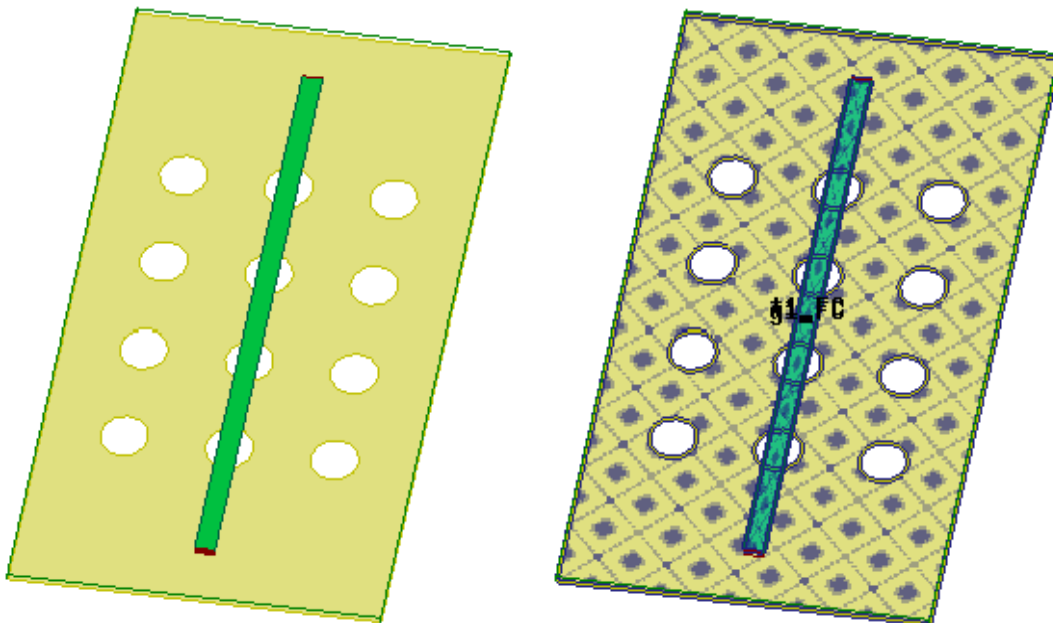

Figure 2-4 Filter model showing Finite Conductivity boundary applied to the trace and the ground plane

This boundary is also known as finite conductivity boundary condition of finite thickness. When an object cannot be replaced by a sheet, HFSS automatically takes the effective thickness into account known as DC thickness boundary condition. Finite conductivity is also applied to replace large conducting objects by assigning a sheet boundary condition on the surface. This boundary condition is called Finite Conductivity Boundary of infinite thickness or classical skin impedance and is applicable only when the skin depth is much smaller than the size of the object. Finite conductivity boundary condition also allows you to specify the surface roughness of the conducting object on which it is assigned.

Impedance

The Impedance boundary condition represents a resistive or reactive surface or both. It's commonly used to simulate thin materials that have an ohms per square characterization or thin film resistors. Impedance boundary condition is complex and in some cases it's frequency dependent.

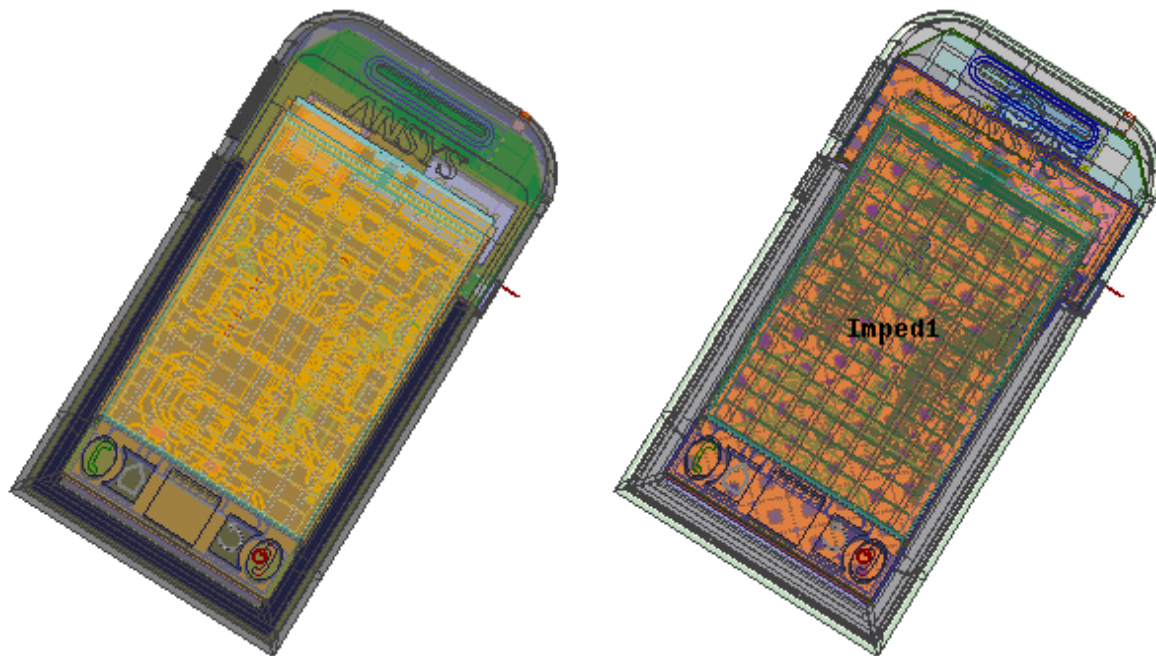

Figure 2-5 Smartphone showing the Impedance Boundary applied to a specific inner surface in order to model conductive paint

Layered Impedance

The Layered Impedance boundary condition is used to model structures that are composed of layers of conducting and/or dielectric materials. This boundary condition is commonly used to model thin multiple plating layers of metallic objects with thin dielectric coatings. Layered impedance boundary condition models multiple layers in a structure as a single equivalent impedance surface. If desired, this boundary can also take into account the conductor surface roughness. Layered impedance is extremely useful since it eliminates the need to mesh thin layers, which in turn, reduces the complexity of the problem and simulates a structure quickly and efficiently. This boundary condition can be specified either on internal or outer surfaces. If it's defined on internal sheet objects (that are two sided) there is an option to use shell elements. Shell elements are advanced layered impedance boundary conditions duplicating the electric

field on the sheet objects. By way of this the tangential electric field can be discontinuous. Shell elements model shielding effects of conducting layers accurately and efficiently.

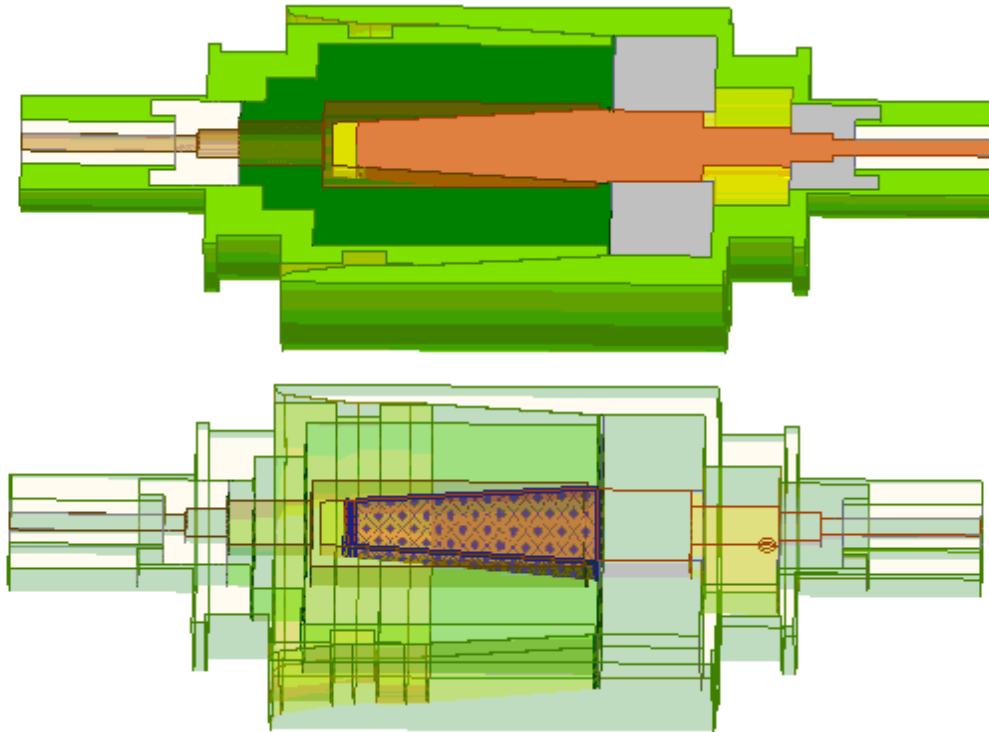

Figure 2-6 Connector model (some parts hidden for clarity) showing the Layered Impedance Boundary applied to surfaces of the connector female center pin

Lumped RLC

The Lumped RLC Boundary is used to model ideal lumped elements like resistors, inductors or capacitors. This boundary can be used to model single elements or multiple R, L, or C in a parallel combination. The following figure shows a capacitor microstrip model showing the RLC boundary applied to a plane internal to the capacitor body.

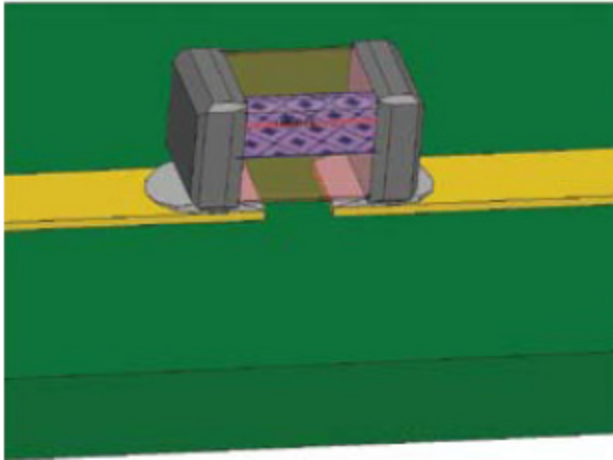

Figure 2-7 Lumped RLC boundary example

Lumped RLC boundary is a modified impedance boundary. Unlike the Impedance boundary Lumped RLC can be used to directly specify a resistor, inductor, or capacitor value in an HFSS simulation. Once the values of R, and/or L, and/or C are specified, HFSS determines the impedance per square of the lumped RLC boundary at each frequency, effectively converting the RLC boundary to an impedance boundary.

A parallel combination of RLC components is obtained by simply specifying values for either two or all three lumped components within the same boundary dialog box. To create series circuits, the RLC boundaries must be applied to two adjoint 2D objects arranged end-to-end. This is shown in the graphic below.

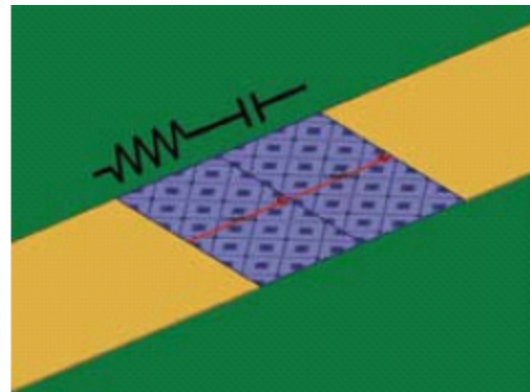
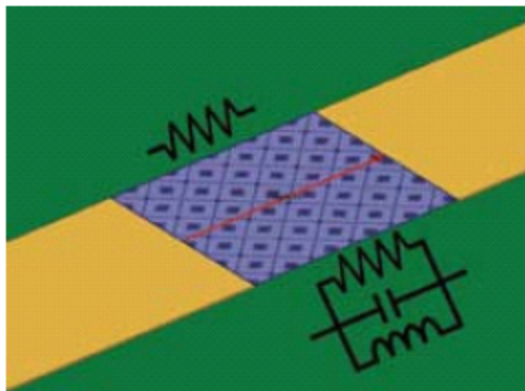

Figure: Microstrip model showing the RLC Boundary applied to a 2D sheet object in order to model a single inline resistor, or inline parallel

Figure: Microstrip model showing the RLC Boundary applied to two end-to-end 2D sheet objects to model a series combination

must be identical to the geometry in contact with the secondary boundary. If the geometries on the primary/secondary pair are not identical, the design cannot be solved.

Each primary and secondary boundary needs a coordinate system that you specify to define the plane on which the boundary exists. These coordinate systems must match each other. If they do not match each other, HFSS automatically transposes the secondary boundary to match the primary boundary. If the resulting primary/secondary surfaces do not have the same relative position, an error occurs.

Perfect Electric Conductor

Assigning a perfect electric boundary condition on a surface of an object causes the tangential component of the electric field to be zero. This type of boundary models a perfectly conducting surface in a structure that forces the electric field to be normal to the surface.

Since no electromagnetic field exists inside 3D objects with pec material, HFSS treats the surfaces of these objects as PEC boundaries. You can define PEC boundary on 2D sheet objects to represent lossless conductors such as transmission line traces or patch antenna elements. When assigning a PEC boundary on a surface that represents the “ground” plane of a radiating structure, select the Infinite Ground Plane option if you want to model an infinite ground plane.

In HFSS, PEC is a default boundary condition on all *outer* surfaces of the computational domain.

The PEC boundary can also be used to create a symmetry plane in a model. In this type of symmetry the E field components are normal to the plane. In the dielectric resonator antenna model shown below, the bottom face of the air volume object is defined as a perfect E boundary.

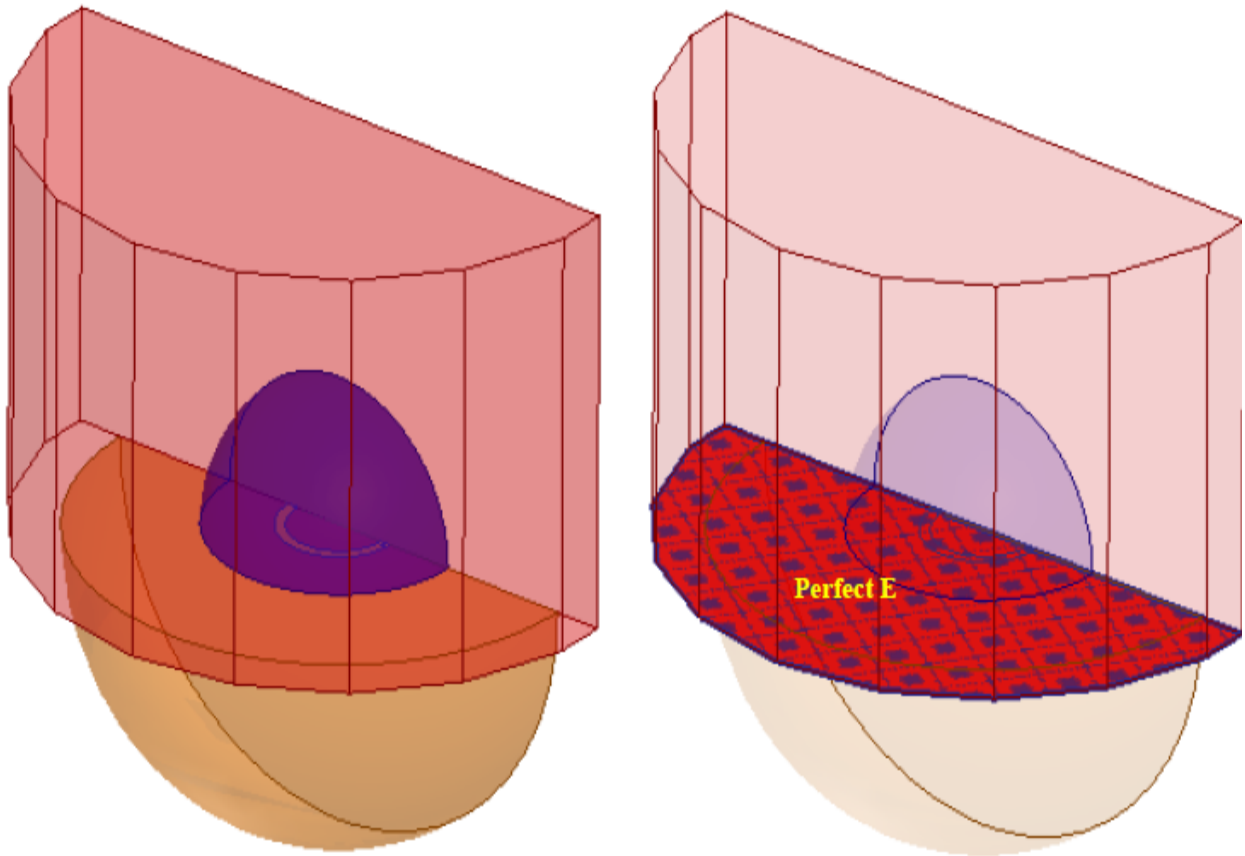

Figure 2-9 Perfect E boundary assigned on the bottom surface of the air volume object

Perfect H

The Perfect H Boundary can be used to create a natural boundary through which fields propagate, or it can be used to model a perfect magnetic conductor.

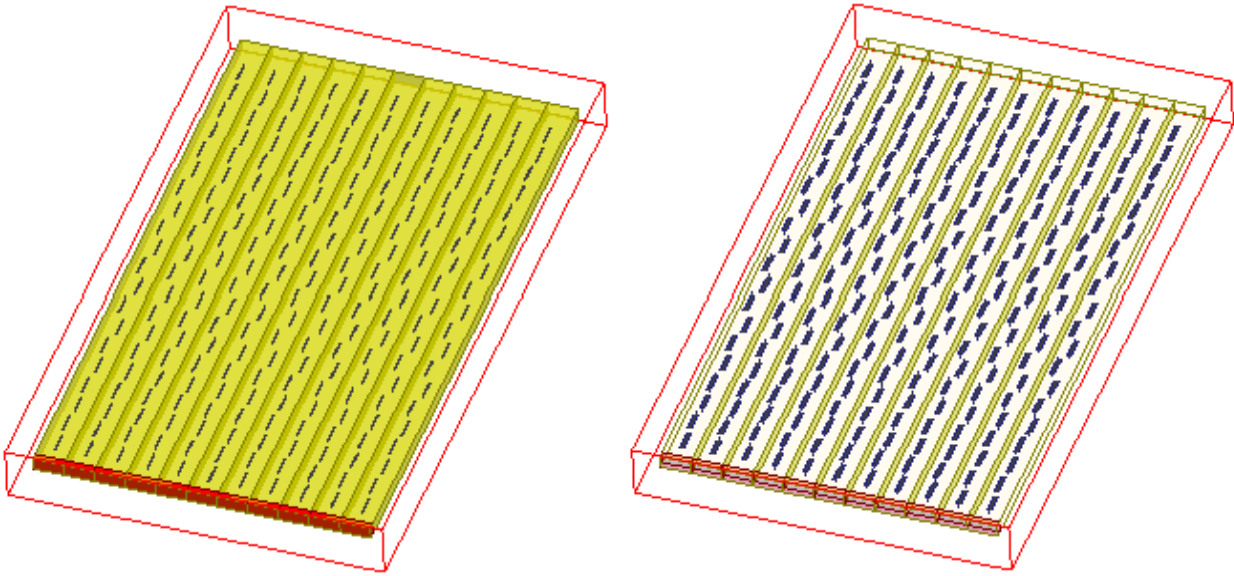

Figure 2-10 Slotted waveguide antenna array with slots assigned perfect H boundary

The Perfect H boundary can be applied either internally to a model or at an outer face of the solution space. If it is applied internally, this boundary forces the tangential components of the H field to be identical on both sides of the surface to which it was applied. If this surface is a conducting body, then the perfect H boundary creates an aperture through which energy can propagate.

If this boundary is applied to an outer face of the solution space, it is equivalent to a perfect magnetic conductor, where the tangential H field is zero.

Radiation Boundary

The Radiation Boundary is used to create an open problem in HFSS that allows electromagnetic waves to radiate infinitely far into space as in the case of antenna designs. HFSS absorbs the wave at the radiation boundary, essentially ballooning the boundary infinitely far away from the structure. Radiation boundary is applied only on outer faces of the solution space. When simulating an antenna place the radiation boundary approximately at a quarter wavelength away from any radiating surface.

The following example shows a probe feed patch antenna design. Radiation boundary is assigned on all outer surfaces of the air box enclosing the antenna except the bottom face, which is a conductor in the real model.

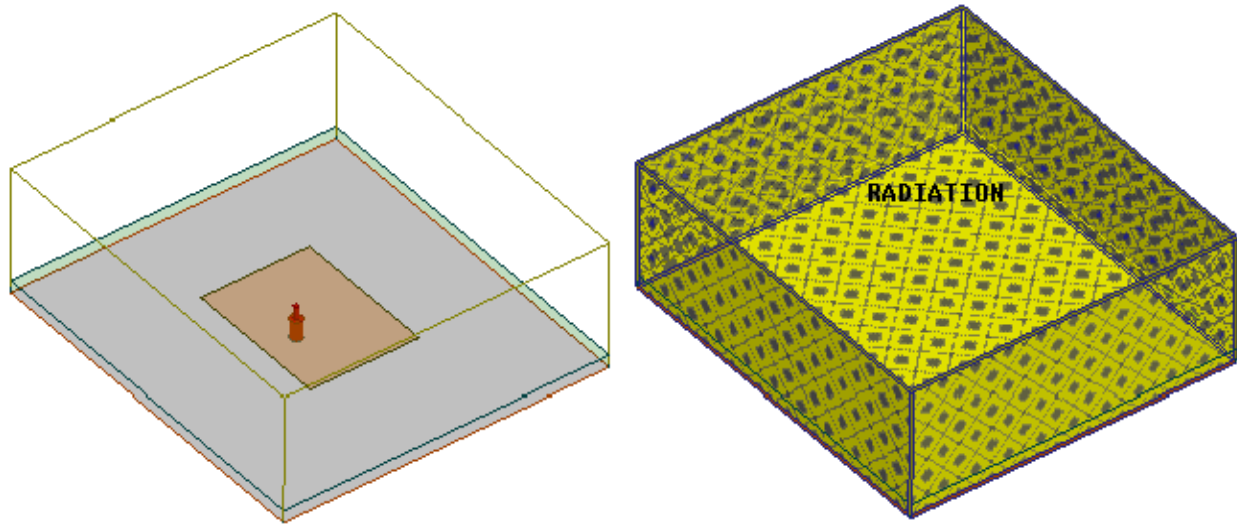

Figure 2-11 Sample HFSS model of a probe feed patch antenna showing radiation boundary

The radiation boundary condition is an approximation of free space. The accuracy of the free-space approximation depends on the distance between the boundary and the closest radiation/scattering object.

Symmetry

The Symmetry Boundary can be used to reduce the overall size of a model by applying it along a plane of geometric and/or electrical symmetry. The symmetry boundary are of two types: the E symmetry and H symmetry.

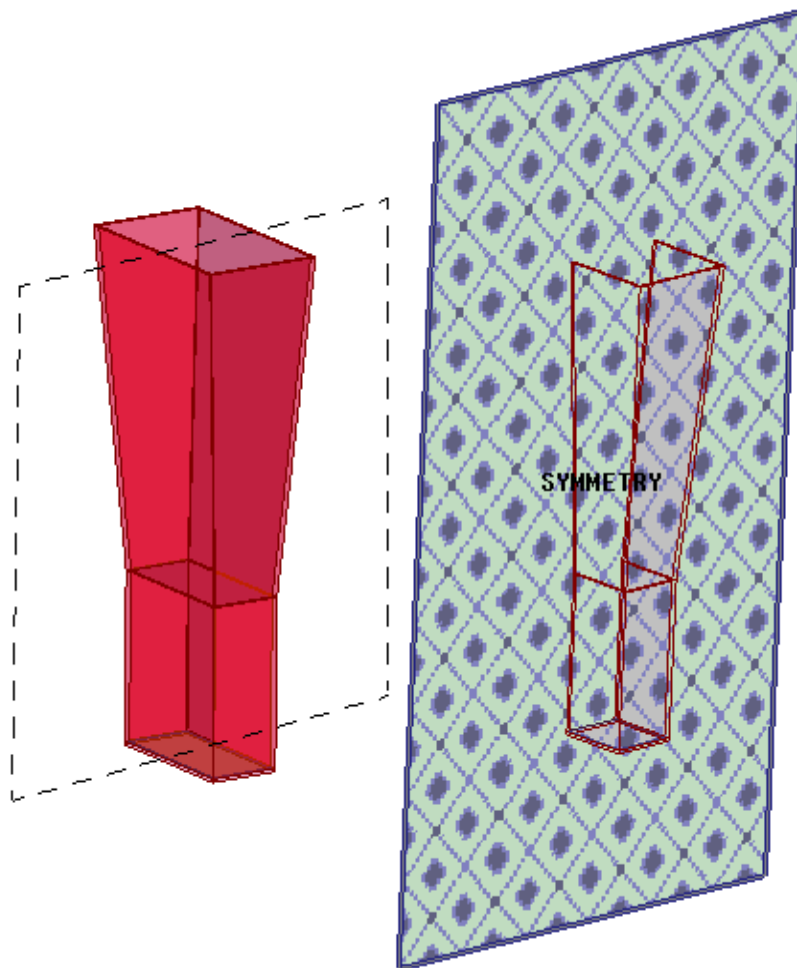

Figure 2-12 Pyramidal horn antenna model showing the perfect H Symmetry Boundary applied to symmetry plane

Symmetry boundaries represent perfect E or perfect H planes and enable you to model only part of a structure, which reduces the size or complexity of the design and shortens the solution time. When a symmetry boundary is applied, the electromagnetic field is forced to **be** either tangential or normal to the symmetry plane. If an E-symmetry plane is used, the electric field is forced to be normal to the symmetry plane; in other words the tangential component of the electric field is zero.

An H-symmetry plane forces the magnetic field to be normal to the plane of symmetry; in other words the tangential component of the magnetic field is zero.

Symmetry planes can be applied only to outer faces of the solution space. The symmetry plane must be planar. For an HFSS simulation, a maximum of three orthogonal symmetry planes can be used.

Note: Symmetry boundary conditions are nothing other than perfect E and perfect H boundary condition.

When calculating far field the post processor mirrors the solution according to the symmetry conditions.

Two common examples of a symmetry boundary are shown below. (Only the modeled halves are shown.)

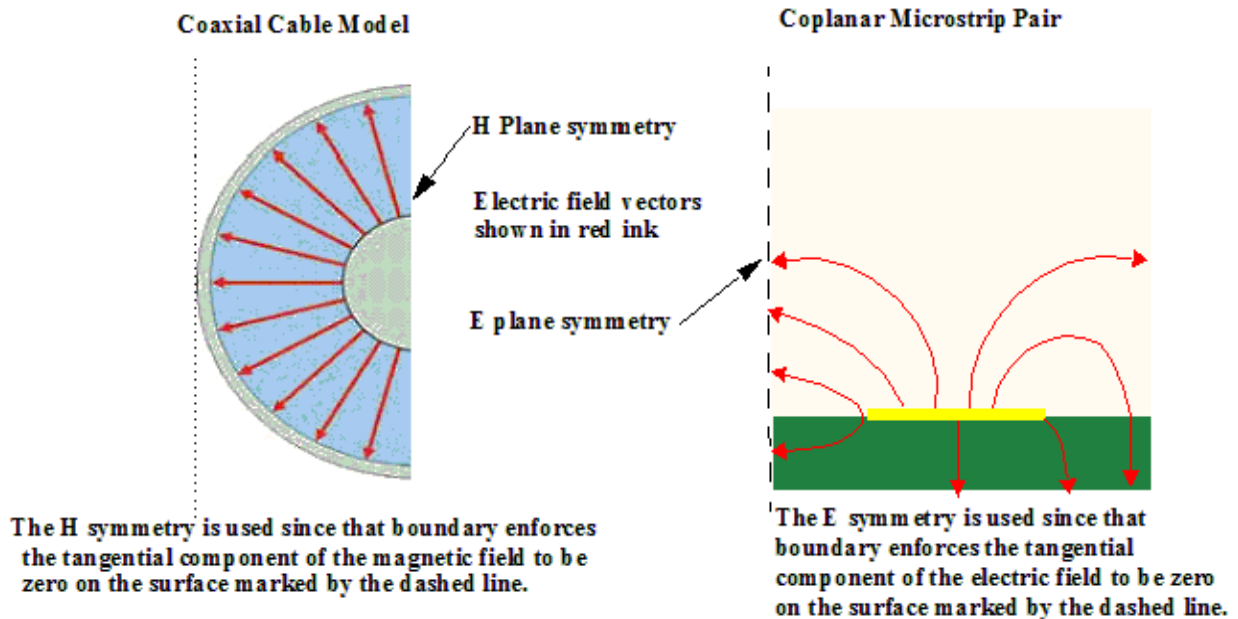

This boundary is not available for models using the Driven Terminal Solution type.

Perfectly Matched Layer (PML)

The Perfectly Matched Layer or PML Boundary is also used to create an open model. Like the Radiation Boundary, it should be applied only on the outer faces of the solution space. It is also the preferred boundary condition when simulating antennas.

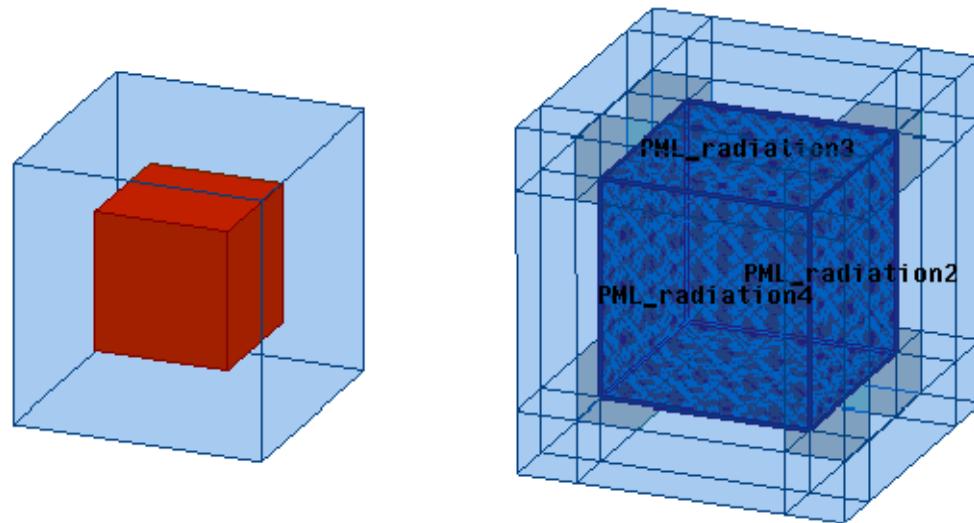

Figure 2-13 Radar cross-section with *Perfectly Matched Layer Boundary*

Perfectly matched layers, though not boundaries in a strict sense, are fictitious materials that absorb the electromagnetic fields impinging upon them. These materials have complex and anisotropic material properties.

Perfectly Matched Layers (PMLs) are the preferred boundary when simulating antenna models and they are more appropriate than radiation boundaries for antenna simulations. PMLs can reduce the solution volume since they can be positioned at a distance $1/10$ times the wavelength close to any radiating structure. For modeling antennas, it is recommended to keep the PML a quarter of a wavelength away from any radiating structure.

Perfectly matched boundaries are automatically generated with the aid of the PML Wizard. This wizard guides you through the creation of the PML objects/materials.

How to Apply Boundary Conditions

Boundary conditions are applied either on 2D sheet objects or one or more faces of 3D objects

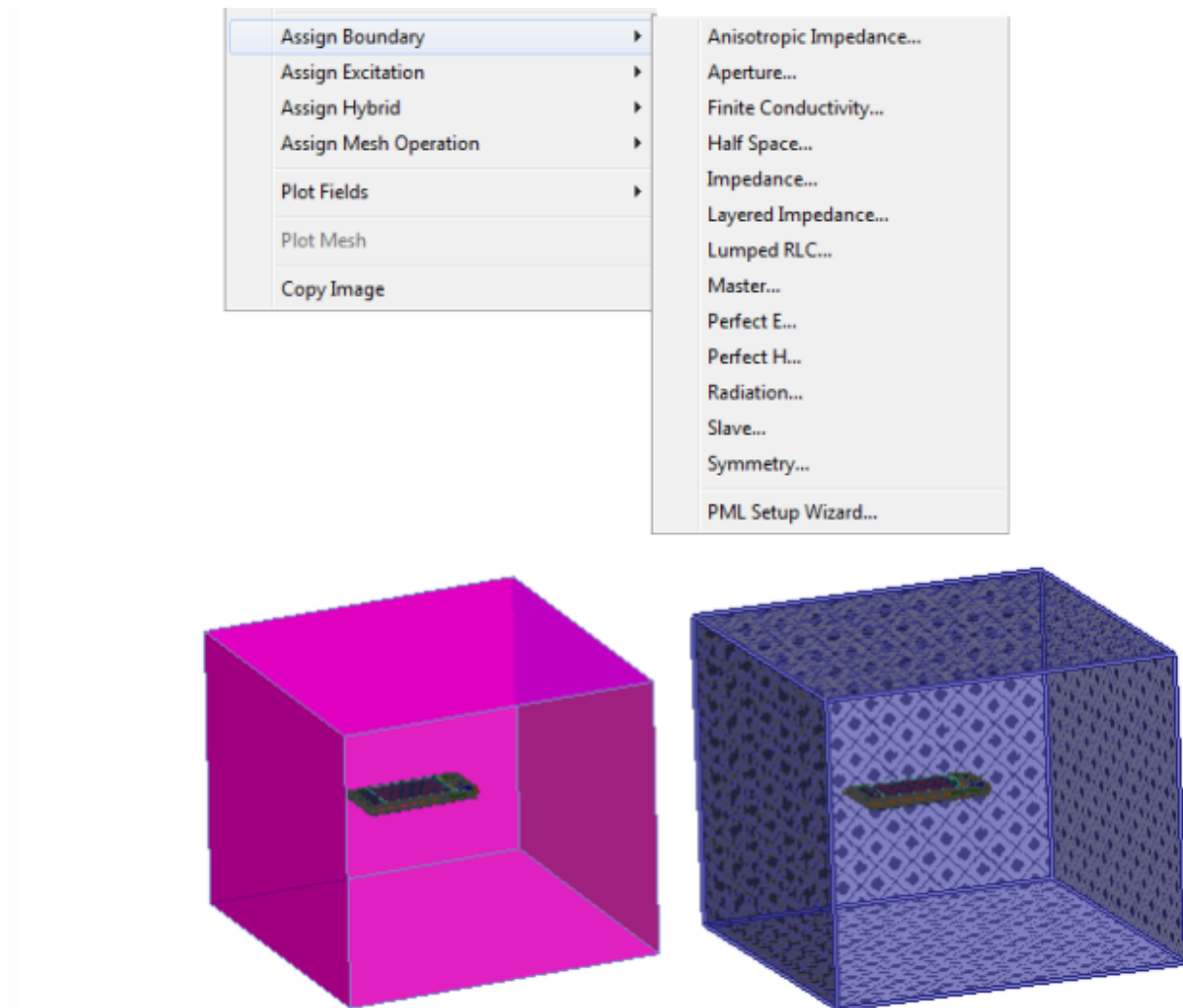

Figure 2-14 Applying boundaries

To apply a boundary condition on a model, perform the following steps.

1. Press the **F** key to enter the face selection mode.
2. Select a single surface of the model or select multiple surfaces of the model to apply a boundary.

Note: If you want to assign a boundary condition on all surfaces of the model, select a face on the model and right-click to select **All Object Faces**.

3. Right-click and select **Assign Boundaries** and click the appropriate boundary condition from the short-cut menu.

This command brings up the dialog box of the selected boundary type. After you define the appropriate boundary condition settings in the dialog box that appears, the boundary condition gets assigned on a single face, multiple faces or on all object faces depending upon your selection.

Alternatively click the surface or multiple surfaces to apply boundary, select the menu item **HFSS** and go to **Boundaries > Assign >** and select the appropriate boundary.

Auto-Open Region

The **Auto-Open Region** option appears on the **Solution Type** dialog box as an HFSS Driven solution, and it is used with a driven modal, terminal or a transient options for a design.

For an open problem such as an antenna array design, the air volume enclosing the outer radiating surfaces is modeled by a surrounding object. On the outer surfaces of this object, boundary conditions such as radiation boundary, PML, or FEBI are assigned to absorb all outgoing waves.

If you select the **Auto-Open Region** option, HFSS automatically creates an invisible bounding region with the default absorbing boundary conditions (ABC) on the outer surfaces of this region. This command eliminates the need to manually create an air box or define a region and assign radiation boundary conditions on the outer surfaces of the air box or the region.

If you want to override the default radiation boundary with a FEBI boundary for a driven modal or terminal problem, select the **FEBI** option under the **Auto-Open Region** check box.

In addition to creating the region object, the **Auto-Open Region** command also automatically adds a solution setup with a default frequency of 1 GHz. Depending upon your requirements you can adjust the solution frequency; as a result the invisible region object is automatically resized.

Generally the **Auto-open Region** command is used when you are interested in viewing the radiation pattern of a device such as an antenna. S-parameters are also obtained. The figure below shows the radiation pattern for a five element array of flared dipole antennas with a trough reflector solved using the default settings of the **Auto-Open Region** mode.

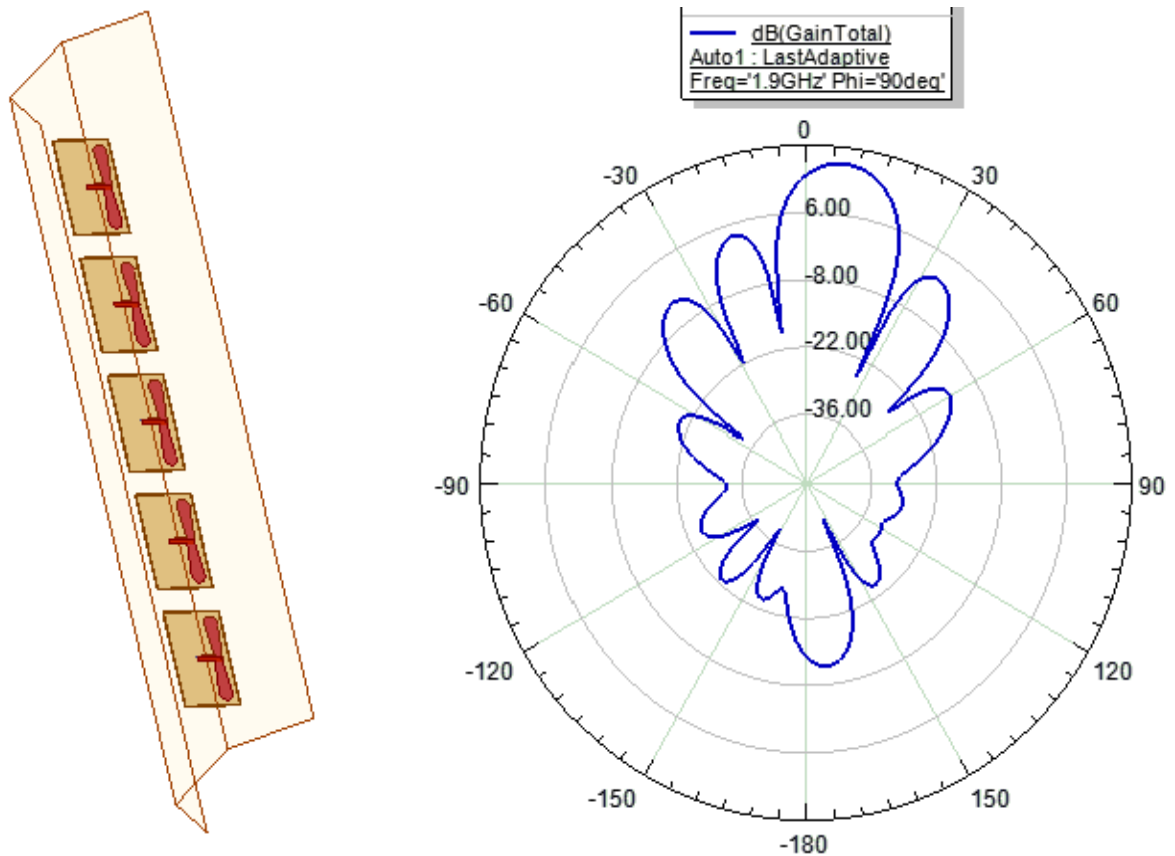

Figure 2-15 Planar dipole antenna array solved using auto-open region

Note: See [Create Open Region](#) for an alternative method for treating open problems in HFSS.

Create Open Region

The **Create Open Region** command automatically creates an open region to model the air volume enclosing the design and assigns boundary conditions on the surface of the region depending upon your selections. You can select a radiation boundary (ABC), FEBCI or PML boundary condition on the **Create Open Region** dialog box. You can also choose an infinite ground plane.

The padding for the region is determined by the operating frequency. This operating frequency is the same as the frequency defined in the solve-setup. If there is no solve-setup defined, the operating frequency defaults to 1 GHz.

If you adjust the adaptive frequency on the solve setup, you can update the operating frequency on the **Update Open Region** dialog box. The padding (PD) for the region is determined by the following rules:

- $PD = \lambda / 3$, for radiation boundaries (or ABC)
- $PD = \lambda / 8$, for FEBI boundaries
- $PD = \lambda / 4$, for PML boundaries

Note: λ (Lamda) is the wavelength at the specified solution frequency. $\lambda = c / f$, where f is the operating frequency in Hertz, and c is the speed of light in a vacuum.

For a design with multiple solution setups, you only need to create the region once and update the operating frequencies accordingly to ensure the appropriate region padding.

The figures below show the model of a planar flared dipole array antenna and the total gain of the antenna array using the **Create Open Region** command with PML boundary. The same model was also solved in the **Auto-Open Region** mode with ABC and from the plots it is clear that results agree.

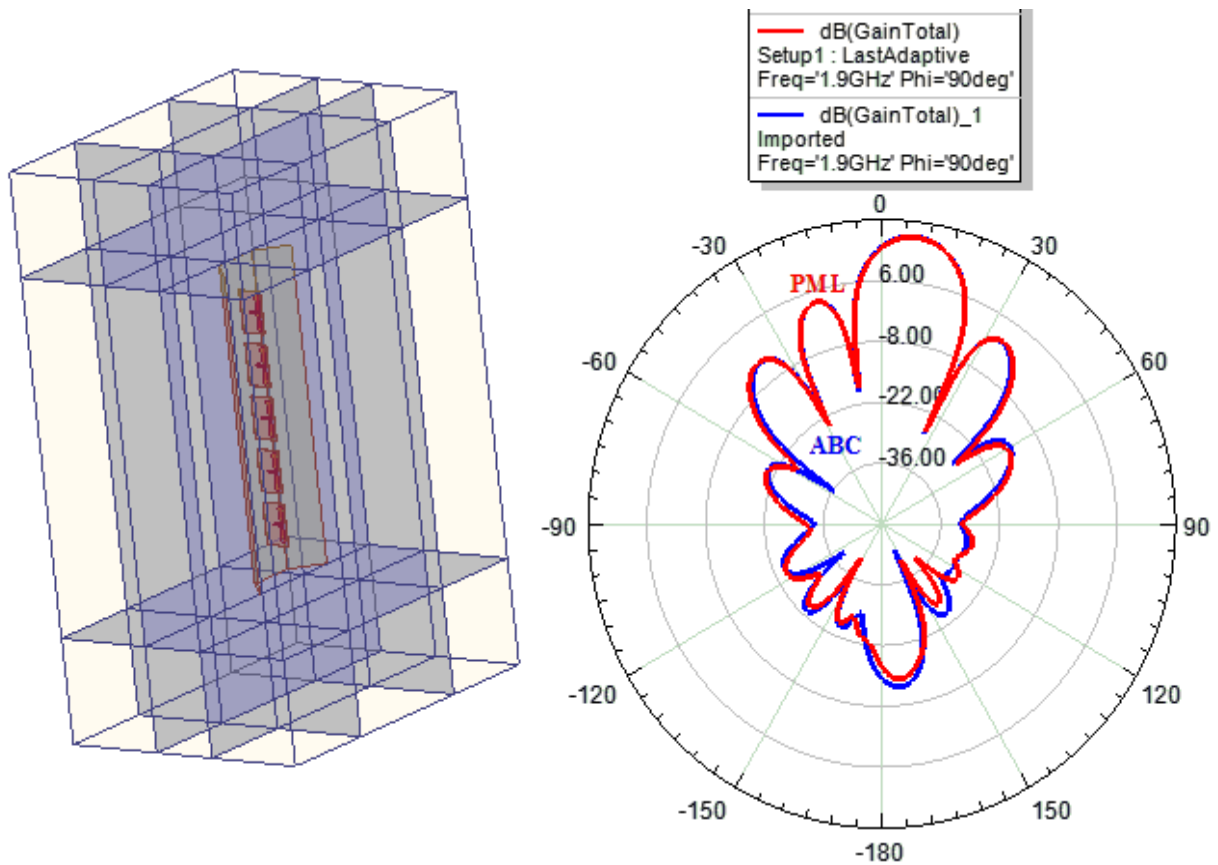

Figure 2-16 Planar Flared Dipole Antenna Array

Note: You cannot create an open region if the **Auto-Open Region** option is checked. If the **Auto-Open Region** mode is active and you clear the **Auto-Open Region** check box, then the bounding box along with the ABC or FEBI boundary becomes visible.

3 - HFSS Excitations

- ["Excitations in HFSS" below](#)
- ["Wave Ports" on the next page](#)
- ["Wave Ports for Terminal Solutions" on page 3-4](#)
- ["Lumped Ports" on page 3-5](#)
- ["Difference between Lumped Ports and Wave Ports" on page 3-8](#)
- ["Floquet Ports" on page 3-9](#)
- ["Incident Waves" on page 3-10](#)
- ["Linked Fields" on page 3-10](#)

Excitations in HFSS

In HFSS, excitations are sources of electromagnetic fields in a design. There are many types of excitations in HFSS. They are listed below:

- Wave Ports
- Lumped Ports
- Floquet Ports
- Terminal
- Incident Wave
- Linked Fields
- Current Sources
- Voltage Sources
- Magnetic Bias Sources

All excitation types provide field information, but only the wave port, lumped Port, and Floquet port provide S- parameters. The use of the magnetic bias source allows you to model a magnetic bias acting on a ferrite material.

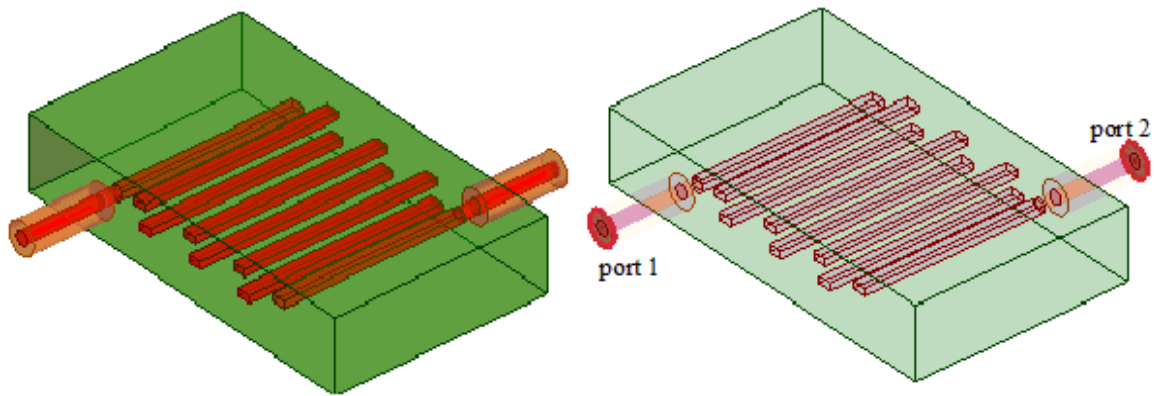

Figure 3-1 Bandpass filter with ports

By assigning excitations you define sources of electromagnetic fields. The most commonly used types of excitations are ports. They are of two types: wave ports and lumped ports. They provide S, Y, Z parameters and field information. Additionally, wave impedance and propagation constant that is gamma are obtained if you assign a wave port. Gamma and wave impedance are related to the transmission line structure represented by the wave port. Depending upon the solution type, wave ports and lumped ports can be either modal or terminal. Terminal wave ports or terminal lumped ports are used for signal integrity problems.

For periodic structures defined by primary/secondary (Lattice pair) boundaries Floquet ports are used.

There are several types of analytically defined incident field excitations of which plane wave is the most common. Linked field come from other designs by using data link and/or measurements.

Wave Ports

Wave ports are used to excite transmission lines like microstrip, stripline, coplanar waveguides, and hollow waveguides. A wave port represents the region through which electromagnetic energy enters or exits the solution space. In HFSS a wave port is treated as if it were a semi infinitely long waveguide or transmission line of the exact same cross-section attached to the model where it's excited.

Wave ports yield S,Y,Z parameters, characteristic wave impedance, and the propagation constant gamma. The S-parameters generated by a wave port are normalized to the matched loads and can also be normalized to any constant complex impedance.

S-parameters can be de-embedded into or out of a port. This operation subtracts or adds transmission line length to the model changing the S-matrix accordingly.

A wave port excitation should be applied only to an outer face of the solution space. HFSS first calculates a 2D solution for the wave port and subsequently uses that solution as the source for the 3D model. HFSS treats each wave port as if it were connected to a semi-infinite waveguide or transmission line that has the exact same cross-section and material properties as the port. Initially, 2D fields in this semi-infinite waveguide that are solved. Those same fields are impressed onto the port region of the 3D model to obtain a solution to the 3D model.

HFSS generates a solution by exciting each wave port individually, wherein each desired incident mode contains 1 Watt time-averaged power. To find a solution to a given port, the desired port is energized with 1 watt of power while all other ports have matched loads.

When creating a wave port in the driven modal solution type, you must specify the number of modes desired. For signal integrity problems, the number of modes should be set equal to the number of signal traces that are enclosed within the given wave port. For example, in the case of a co-planar pair of microstriplines enclosed within a single wave port, two modes should be specified. In the final solution, these two modes represent the even and odd modes of propagation.

Some examples of commonly used wave ports are shown below.

The following figure represents differential pair via model with a pair of lines transitioning through the vias to a pair of striplines on a lower layer. Wave ports have been defined as shown below on the differential pair via model. There are four terminals at the intersections of the conducting objects with the port face.

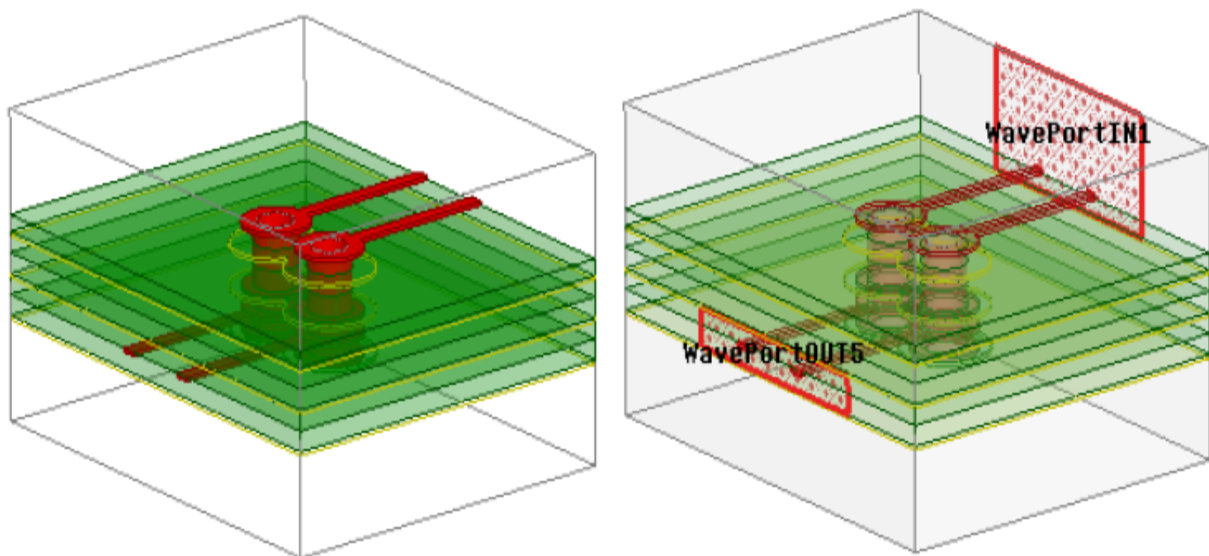

Figure 3-2 Differential via pair model showing wave ports and terminals

Wave ports assigned on waveguide structures are naturally defined by the cross-section of the waveguides. For transmission lines (i.e. microstrip, coplanar waveguides, slotline etc.) ports should be defined carefully. Also, placement of a wave port is critical since it can affect the accuracy of the solutions.

Note: For more information see the topics Wave Port Size and Wave Port Placement in the help.

Additional examples of models with appropriate wave port dimensions are shown below.

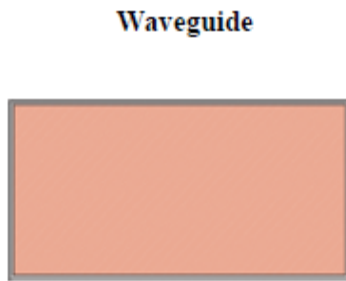

Figure: Port size is determined by inner dimensions of waveguide.

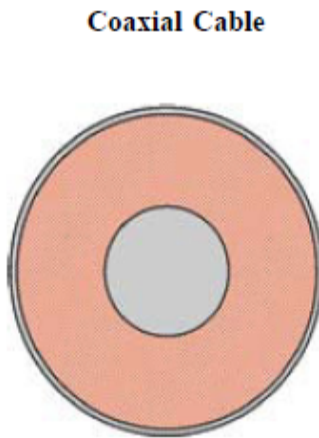

Figure: Port size is determined by inner radius of shield.

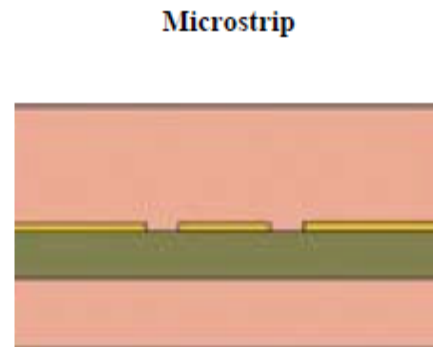

Figure: Bottom of port touches ground plane of microstrip.

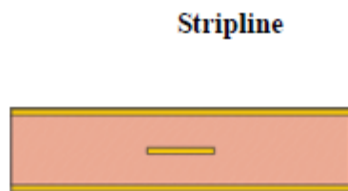

Figure: Port height is determined by ground plane spacing, and port touches both upper and lower ground planes.

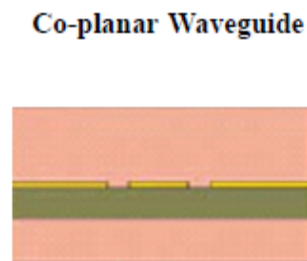

Figure: Left and right edges of port should touch left and right ground planes of CPW.

For a wave port in the driven terminal solution type, the location and number of modes needed is automatically determined by HFSS.

Wave Ports for Terminal Solutions

Terminals are the ends of signal traces that intersect the plane of a port. To fit circuit theory HFSS has options for assigning terminals and expressing the relationship between currents and

voltages.

Terminals are especially useful when you are dealing with circuit simulators since the S-parameters obtained in terms of currents and voltages are in a format that is compatible with most circuit simulators. The terminals for the transmission line below are T1, T2, T3, T4.

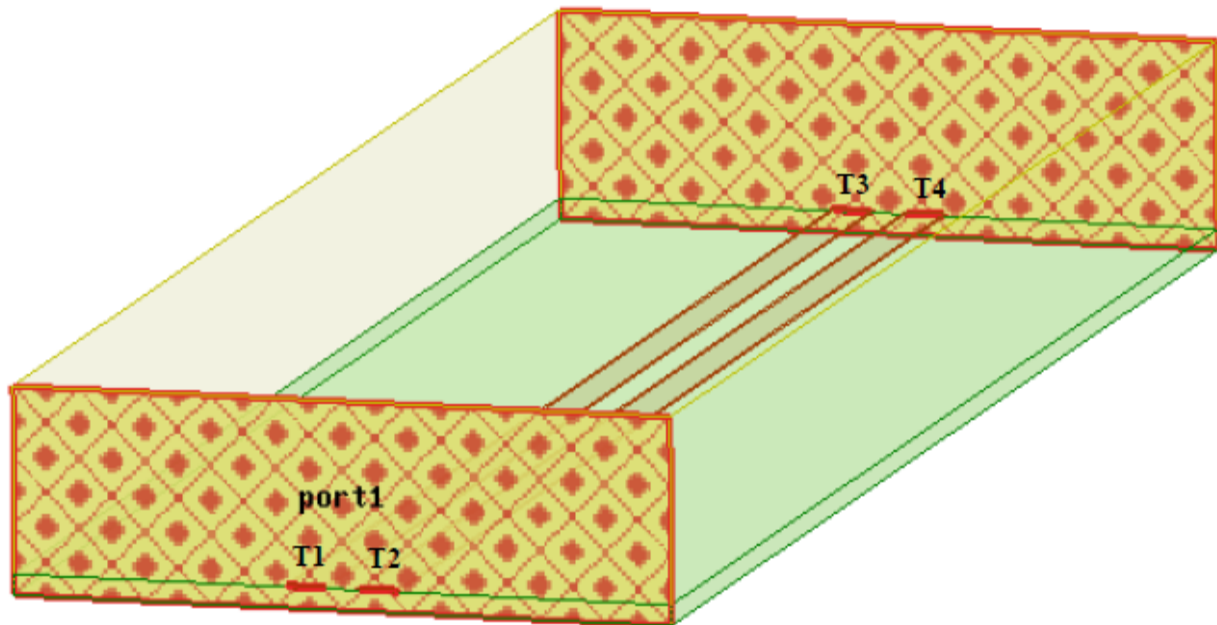

Figure 3-3 Transmission line examples

Lumped Ports

Lumped Ports are commonly used excitation types in HFSS. A lumped port is analogous to a current sheet source and can also be used to excite commonly used transmission lines. Lumped ports are also useful to excite voltage gaps or other instances where wave ports are not applicable. Generally they are applied internally to the solution space.

Shown below are examples of commonly used lumped ports on a microstrip model applied between the signal traces and the ground plane.

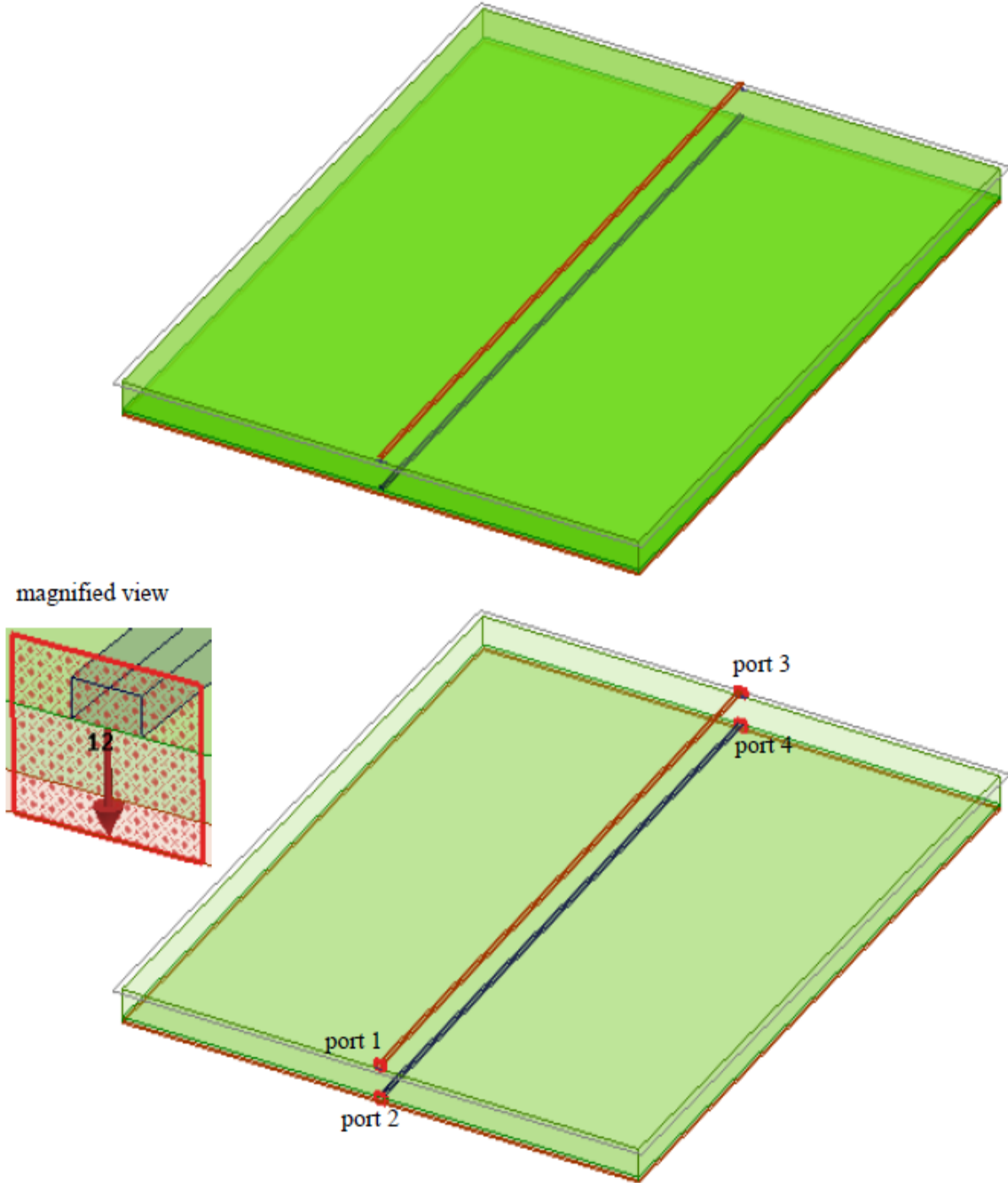
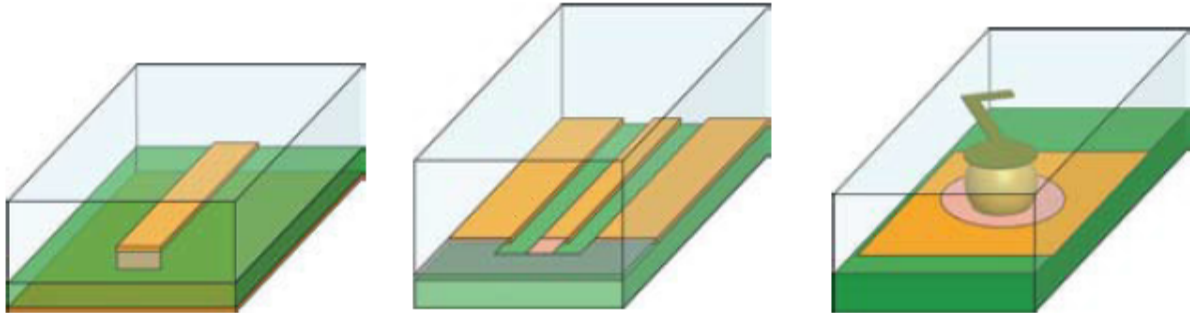

Figure 3-4 Lumped ports excitations



(region represents the lumped port.)



<p>Port is internal to the solution Space. The 2D port rectangle touches the signal trace with one edge and the opposite edge touches the ground plane.</p>	<p>Port is internal to Solution Space. The 2D port rectangle touches the signal trace with one edge, and the opposite edge touches user-drawn PEC objects (gray.)</p>	<p>Port is internal to Solution Space. Port is an annular ring around BGA Ball.</p>
---	---	---

Lumped ports yield S,Y,Z parameters and fields, but they do not yield any gamma or wave impedance information. The results of a lumped port cannot be de-embedded but can be renormalized. Unlike wave ports, lumped ports can support only a single mode. A lumped port can be defined on any 2D object that has edges in contact with two conducting objects. The boundary that is applied to all edges that do not touch a conductor is a perfect H, which ensures that the normal electric field is equal to zero on those edges.

The complex impedance Z_s defined when the port was created, serves as the reference impedance of the S-matrix of the lumped port. The impedance Z_s has the characteristics of a wave impedance; it is used to determine the strength of a source, such as the modal voltage V and modal current I , through complex power normalization.

It should also be noted that when the reference impedance is a complex value, the magnitude of the S-matrix is not always less than or equal to 1, even for a passive device.

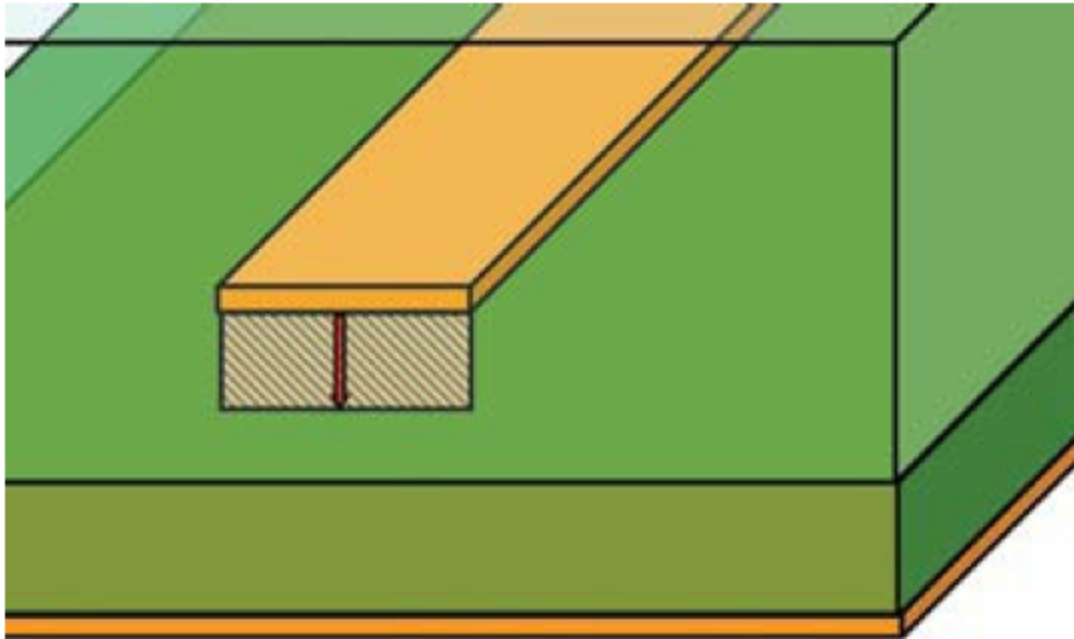

Difference between Lumped Ports and Wave Ports

Wave ports are applied at outer faces, yield S, Y, Z parameters, fields, wave impedance, gamma, and can be deembedded.

Generally lumped ports are applied internally, yield S, Y, Z parameters and fields. Both can be renormalized to a specific real impedance.

Port	applied	Gamma	Yields S,Y,Z	Renormalize	De-embed
Wave	externally	yes	yes	possible	possible
Lumped	internally	no	yes	possible	not possible

The main differentiator between lumped ports and wave ports is the location of where they are applied to the model. Wave ports should only be applied at outer faces of the solution volume, whereas the lumped port should only be used internally to the solution volume.

Another key difference is that wave ports are specifically suited to sourcing ideal transmission lines, while lumped ports are well suited to sourcing structures that are not ideal transmission lines such as BGA balls, bondwires, etc.

Lumped ports are also called gap ports. This is because the height of the lumped port is small when terminating feeding non-ideal transmission lines.

Floquet Ports

A Floquet port in HFSS is exclusively used for planar-periodic structures. Typical examples are planar phased arrays and frequency selective surfaces when these may be idealized as infinitely large. The analysis of the infinite structure is accomplished by analyzing a unit cell. When you define a Floquet port, a set of modes known as Floquet modes represent the fields on the port boundary. The Floquet modes are plane waves with propagation direction set by the frequency, phasing, and geometry of the periodic structure.

To illustrate a unit cell of an infinite phased array of vivaldi antennas can be simulated using linked boundaries and a Floquet port. The upper face of the unit cell is terminated in a Floquet port as shown in the following figure.

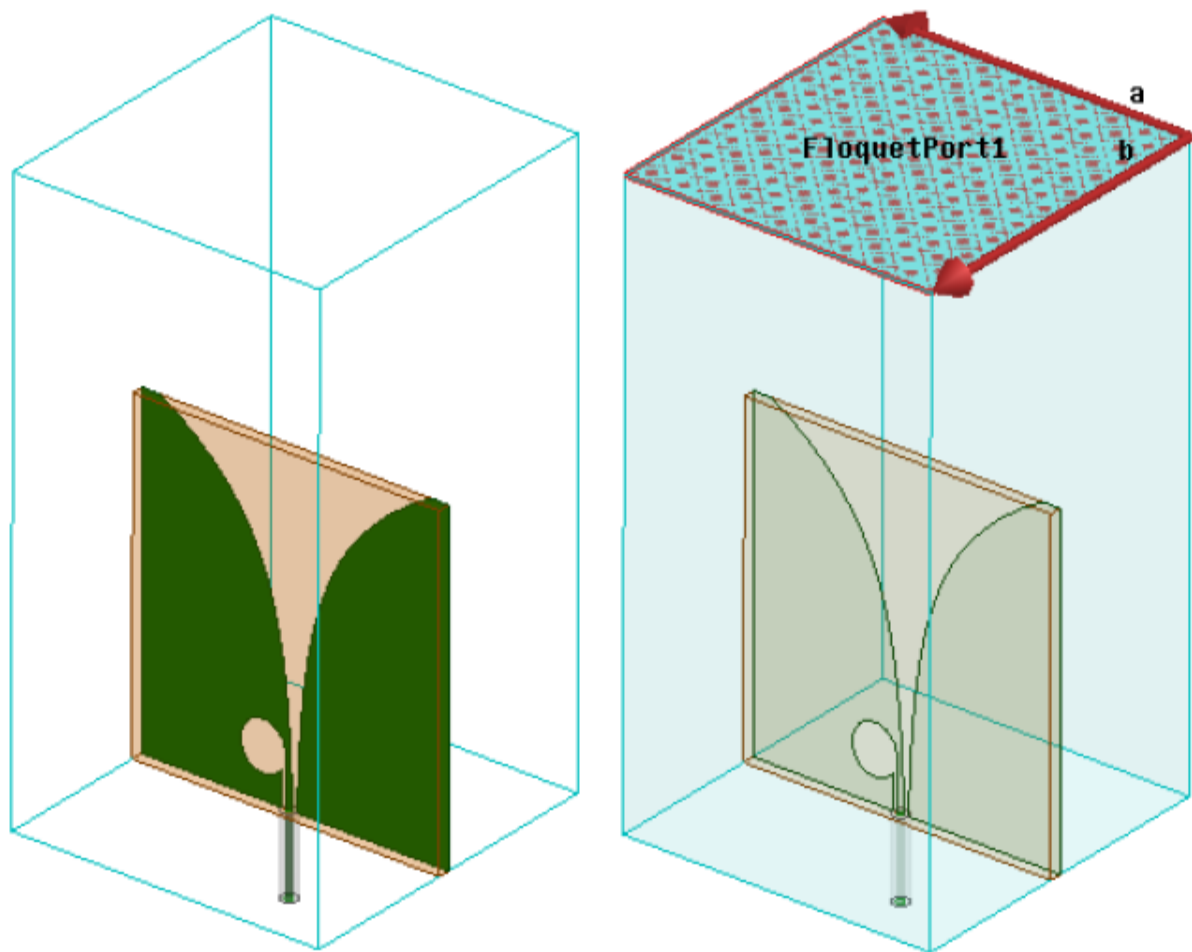

Figure 3-5 Floquet Ports example on a unit cell

Incident Waves

An incident field is the electromagnetic field in the absence of any scatterers. Incident fields are of the following types:

- Plane Wave
- Hertzian-Dipole Waves
- Gaussian Beam
- Linear Antenna Wave
- Cylindrical Wave

The most commonly used incident wave is the plane wave. For example, incident plane wave source excitations can be used to see the scattering from a standard radar cross-section model of a conducting ogive.

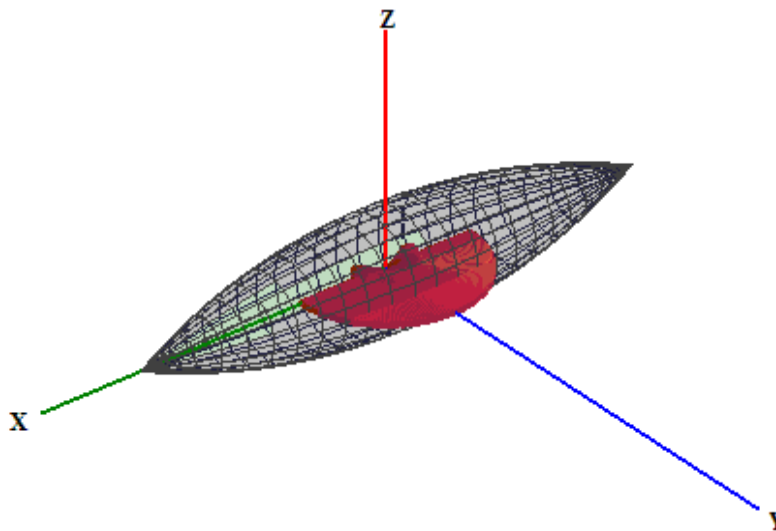

Figure 3-6 Incident plane wave on an aluminum ogive

Linked Fields

Linked fields are of two types:

- Far Field Wave
- Near Field Wave

A far field wave originates at a distance several wavelengths from the computational domain. Far field values are defined on the surface of a unit sphere. When you use a Far Field link, the origin of the global coordinate system of the source project should be in the phase center of the antenna.

A near field wave source is close enough to the design, typically within one wave length. The radiation surface of the near field source project cannot coincide with the surface of the target project where the incident field pings in.

The following design of a dish antenna fed by a circular horn antenna can be used with near field sourcing to run a range of analyses.

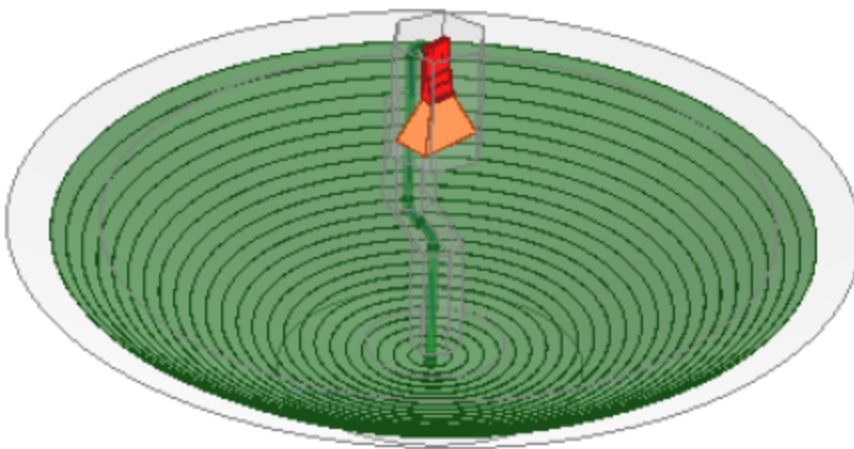

Figure 3-7 Near Field example of a dish antenna

Both the near and far field link establishes a one-way link. The feedback from the target to the source is neglected.

4 - HFSS Solution Setup

- ["Driven Solution Setup" below](#)
- ["General Tab" on page 4-5](#)
- ["Solution Frequency Setting for Advanced Setups" on page 4-5](#)
- ["Adaptive Solutions" on page 4-6](#)
- ["Options Tab" on page 4-7](#)
- ["Initial Mesh Options" on page 4-8](#)
- ["Adaptive Options" on page 4-8](#)
- ["Advanced Solution Setup Options" on page 4-8](#)
- ["Adaptive Options" on page 4-8](#)
- ["Initial Mesh Options \(Advanced\)" on page 4-9](#)
- ["Port Options" on page 4-9](#)
- ["IE Solver Options" on page 4-9](#)
- ["Fields" on page 4-10](#)
- ["Expression Cache Tab" on page 4-10](#)
- ["Defaults Tab" on page 4-10](#)
- ["Transient Solution Setup" on page 4-10](#)
- ["Transient Solver" on page 4-11](#)
- ["Input Signal" on page 4-12](#)
- ["Duration" on page 4-13](#)
- ["Save Fields" on page 4-13](#)
- ["Radiated Fields" on page 4-13](#)
- ["HPC and Analysis Options" on page 4-13](#)
- ["Domain Decomposition" on page 4-14](#)
- ["The Maximum Number of Passes and Maximum Refinement Per Pass" on page 4-15](#)
- ["Frequency Sweeps" on page 4-16](#)
- ["Differences between Local, Remote and DSO solutions" on page 4-19](#)

Driven Solution Setup

A driven solution setup is defined for an HFSS Driven modal or a terminal project. Defining a solution setup enables HFSS to compute a solution for a design. You can define multiple solution setups for the same design. As illustrated in the following figure if you right-click **Analysis** on the **Project Manager** window and select the **Add Solution Setup** option from the short cut menu, you can select, Auto or Advanced.

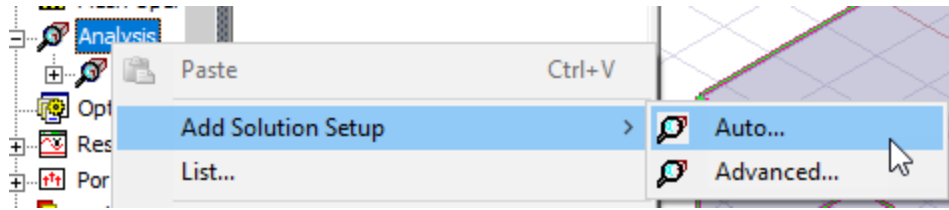

If you select **Auto...**, the following Solution Setup window appears.

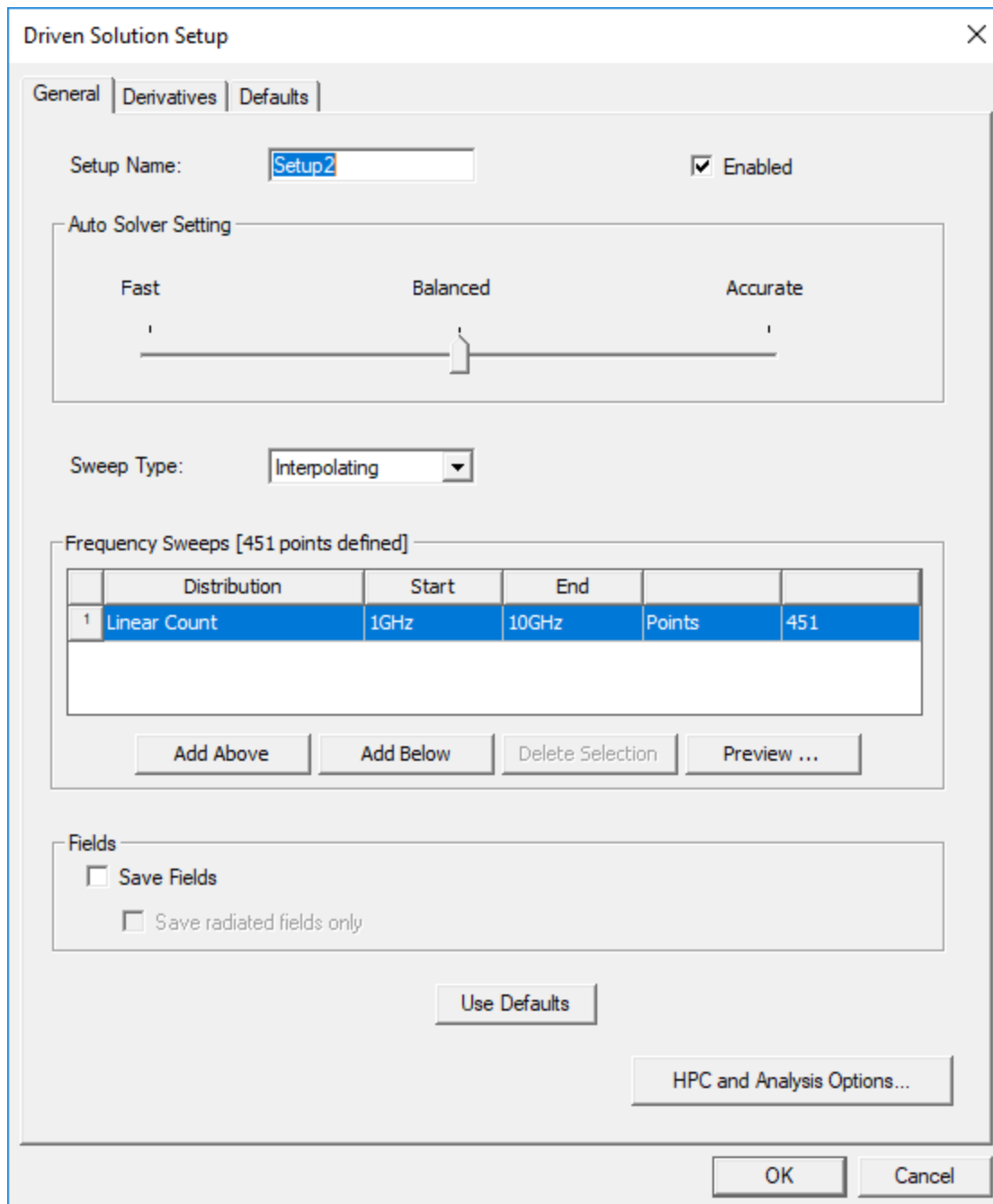

This offers a slider bar with choices for Fast, Balanced or Accurate settings, choices for Sweep Type, and one predefined Frequency Sweep.

If you select **Advanced...**, the following **Solution Setup** window appears. You can specify the settings on the **Solution Setup** window for computing a solution for a design. If you want a Frequency Sweep, you add that separately.

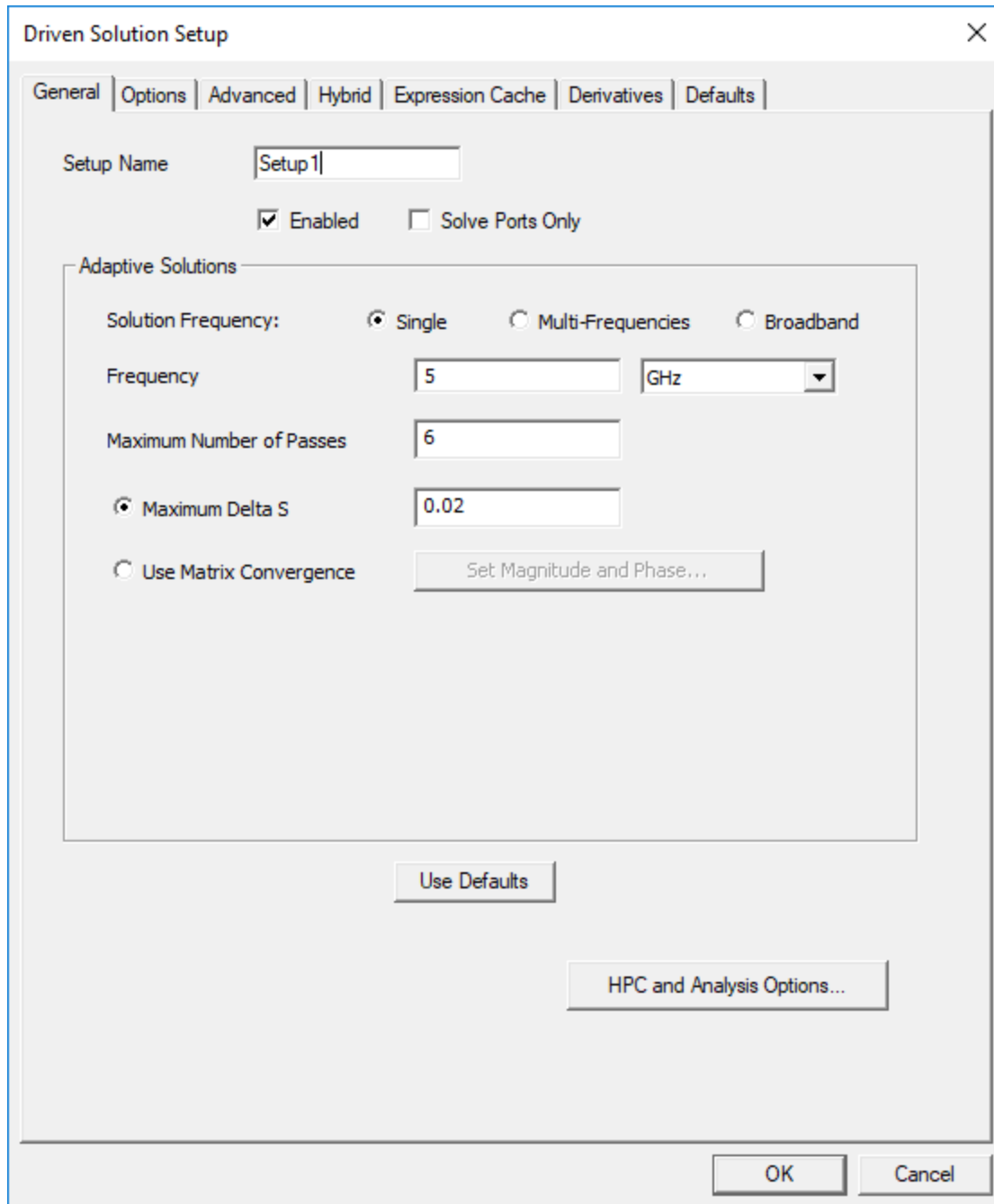

Figure 4-1 Advanced Driven Solution Setup window (General tab) for a driven modal or a driven terminal design

If you want HFSS to quickly compute only the 2D excitation field patterns, impedances, and propagation constants at each port, select the option **Solve Ports Only**. If you select the Solve Ports Only check box, the Adaptive Solutions panel disappears from the General tab. If you clear

the check box, the Adaptive Solutions panel gets reinstated. Some of the options appearing on various tabs for the driven solution setup are discussed below.

General Tab

General is the first tab of the **Driven Solution Setup** window.

For an Auto setup, set the **Auto Solver Setting** to **High Speed, Balanced, or Higher Accuracy**. Choose a **Sweep Type** of either **Interpolating** or **Discrete Sweep**. Select the **Distribution** type, set parameters for frequency start and end, and add the appropriate number of sweeps. Decide whether or not to **Save Fields**. If you are interested in the far field only, select **Save radiated fields only**.

For an Advanced setup, use this tab to define the operating frequency for simulating your design and specify convergence criteria for the simulation. Initially, the **General** tab has default values of 5GHz for the solution frequency, 6 for the maximum number of passes and 0.02 for maximum delta S. These fields are editable.

For either automatic or advanced setups, the **General** tab also allows you to open the **HPC and Analysis Options** window.

The different options and fields available on the **General** tab for Advanced solution setups are further described in:

- [Solution Frequency Setting](#)
- [Adaptive Solutions](#)

Solution Frequency Setting for Advanced Setups

The solution frequency is used by HFSS to determine the maximum initial tetrahedra size and is the frequency at which HFSS explicitly solves the given model.

The solution frequency is the frequency at which HFSS performs the adaptive refinement process, which continues until the solution converges.

The solution frequency is the frequency at which HFSS explicitly solves a given simulation. It is also at this frequency that the adaptive solution operates, and it is the fields at this frequency that are used to determine whether a model has converged or not.

In general the solution frequency should be set to the operating frequency of the device being simulated. To generate a solution across a range of frequencies, define a frequency sweep and set the solution frequency to either the device operating frequency, the center frequency of the sweep, or a frequency that is between 60 and 80 percent of the maximum frequency desired. The frequency that is used depends on what type of frequency sweep will be used.

For most antenna simulations, the solution frequency should be set to the operating frequency of the antenna. For simulations of filters, the solution frequency should be set to the center of the bandpass frequency.

The solution frequency is also the frequency that should be used for any calculations the user performs when creating a model that depend on a frequency. Examples of these types of calculations are air region size for antenna problems, skin depth calculations, PML wizard input, etc.

Adaptive Solutions

Adaptive mesh refinement is an important feature of HFSS that automatically generates accurate solutions. Adaptive Solutions is a panel on the **General** tab of the **Solution Setup** window where you can set the convergence criteria of the adaptive refinement process for solving a design. Convergence is determined by monitoring a parameter from one adaptive pass to the next. The most common convergence criterion is to ensure that the difference in the S-parameter value between two consecutive solves is less than the specified magnitude.

The following options exist on the Adaptive Solutions panel for a modal and terminal project:

- Maximum Number of Passes
- Maximum Delta S
- Use Matrix Convergence

The main control parameter used by HFSS is Delta-S to determine whether a solution has converged or not.

Because of the direct relationship between the electromagnetic fields and the S- matrix, the convergence of the simulation is presented to a user via the delta-S value. The value of delta-S is the change in the magnitude of the S-parameters between two consecutive passes. Delta-S represents the change in the electromagnetic energy between successive solutions. Once the magnitude and phases of all S- parameters change by less than the delta-S value that you specify, the analysis stops and is considered converged. Conversely, in electric field terms, once the electromagnetic energy is no longer changing in the given model, the field solution has converged and is correct. If the desired delta-S parameter is never reached, HFSS continues until the requested number of passes is completed. The maximum delta-S is defined as

$$\text{Max}_{ij} [\text{mag}\{S_{ij}^N - S_{ij}^{N-1}\}]$$

where: i and j cover all matrix entries. N represents the pass number.

Delta-S should be set between 0.005 and 0.1 for most HFSS simulations. A typical convergence plot for Max Mag Delta S across different adaptive passes for a simulation is shown in the following figure.

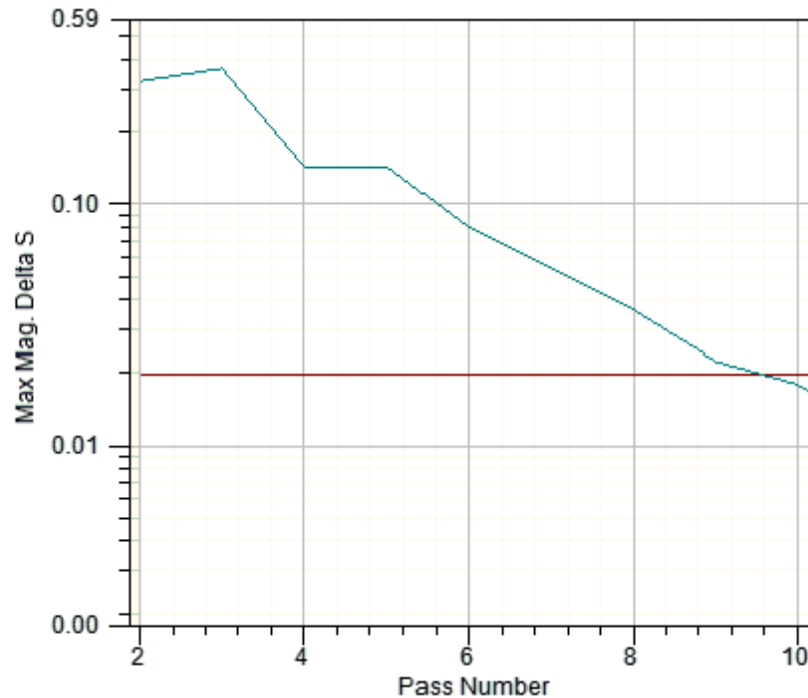

Figure 4-2 Convergence Plot for the Max Mag Delta S

The **Maximum Number of Passes** option is the maximum number of adaptive iterations that HFSS can perform during a simulation. This parameter is the stopping criterion for a simulation.

The **Use Matrix Convergence** command allows you to define a different stopping criteria for specific entries in the S-matrix. The adaptive mesh refinement process continues until the magnitude and phase of the entries in the S-matrix change by an amount that is less than the specified criteria from one adaptive pass to the next or until the requested number of passes is completed. The Matrix Convergence Criteria include settings for all matrix entries, diagonal/diagonal-off matrix entries, or specific individual matrix entries.

Options Tab

Options is the second tab of the **Driven Solution Setup** window for Advanced Solution Setups. This tab includes settings for the initial mesh options for lambda-based refinement and adaptive options for controlling mesh growth by the refinement per pass and the minimum number of passes as well as the minimum number of converged passes. In addition to these settings, you

can also specify the solution options for the type of solver and the type of Basis functions you want to use for a particular problem.

The settings appearing on the **Options** tab are described below.

Initial Mesh Options

The initial mesh options panel consists of lambda refinement settings. The settings are described below.

Lambda Refinement

The initial mesh is based on the 3D solid geometrical model only. It has no bearing on the electrical performance of the device that is being simulated. The lambda refinement process involves refining the initial mesh until most of the mesh elements are approximately a quarter wavelength for air and one third wavelength for dielectrics. A wavelength is based on the single frequency value entered in the **Solution Frequency** field. For almost all cases, lambda refinement should be used. For most problems, it is recommended to accept the default values.

Use Free Space Lambda

The **Use Free Space Lambda** option forces the lambda refinement to target a mesh size that is approximately one-quarter of a wavelength for air. If you select this option, the material properties of objects are ignored. This option can be useful in applications that have dielectrics with very high conductivities. Brain tissue or salt water are examples of materials that produce very high mesh counts even though the RF penetration into the material is limited to a region very close to the surface.

Adaptive Options

This panel deals with adaptive refinement settings and minimum number of adaptive passes and converged passes. The **Maximum Refinement Per Pass** option is the maximum percentage of tetrahedra that are added to the mesh in each adaptive pass. By default **Minimum Number of Passes** is 1. Regardless of whether a solution reaches convergence, it will not stop unless the minimum number of passes that you specify is completed. The option **Minimum Converged Passes** causes the adaptive analysis to continue until convergence criteria is satisfied for the number of passes that you specify in this field. The default is 1. For example if you specify 3 in this field, the analysis runs until the convergence criteria is satisfied for at least 3 adaptive passes.

Advanced Solution Setup Options

This panel provides the options for guiding HFSS with the type of solver and the order of basis functions to use for solving a particular problem.

Note: For more information see the **Basis Functions in HFSS** in the **HFSS Technical Notes**. See also **Fundamentals**.

Advanced Tab

The **Advanced** tab contains further advanced settings for an Advanced solution setup. In most circumstances, you should not change any of the settings on this tab. It is highly recommended that you accept the default settings.

Initial Mesh Options (Advanced)

If you want you can reuse the last adaptive mesh of an existing source design as the initial mesh for a target design. To do this, you can select the **Import Mesh** check box and enter the appropriate settings on the **Setup Link** dialog box to import this solved mesh by linking the solution setup of the source design to that of the target design. For example, this feature can be used if you want to reuse the last adaptive mesh of a unit cell and repeat it for simulating a finite antenna array. In this example, the unit cell is the source design and the solved final mesh of the unit cell is reused as the initial mesh and repeated for the target design of the finite antenna array upon linking the two designs. This approach makes efficient use of the computational resources.

Port Options

The **Port Options** panel appears on the **Advanced** tab of the **Driven Solution Setup** window when your designs include wave port excitations. Port options are the convergence criteria for the port solver. It is recommended that you accept the default settings. Refining the mesh at the ports causes HFSS to refine the mesh for the entire structure as well. This occurs because it uses the port field solutions as boundary conditions when computing the full 3D solution. The mesh for each model port is adaptively refined until it includes the minimum number of triangles. Refinement then continues until the port field accuracy or the maximum number of triangles is reached.

IE Solver Options

This panel contains the options of using the **Auto** setting, **ACA** solver or **MLFMM** Solver. If you select **Auto**, HFSS picks either the **ACA** or **MLFMM** solver depending upon the characteristics of the problem being solved. For solving a design with FEBI boundary condition, IE domains or arrays Direct and Iterative solvers are not supported. For such problems, **ACA** or **MLFMM** solver should be used along with the **Domain Decomposition** setup.

Fields

The **Save Field** option is selected by default. If you are interested in the far field only, then select the option **Save radiated fields** only.

Expression Cache Tab

If you want to specify additional convergence criteria by using output variables or other expressions, click the **Add** button and enter the appropriate settings on the **Add To Expression Cache** dialog box.

Defaults Tab

The **Defaults** tab allows you to save the current settings as the defaults for future solution setups or revert the current settings to the standard setting.

Transient Solution Setup

Transient solution setup is defined for solving problems in the time domain. The settings on the Transient Solution Setup window depend upon your choice of the driven option on the **Solution Type** dialog box. If you select **Network Analysis**, the **Transient Solution Setup** includes the **Input Signal** tab (shown in the following figure). For **Composite Excitation**, the **Input Signal** tab is not present on this window. The signal settings for a composite excitation are on the **Terminal** dialog box. You can launch this dialog by double-clicking the terminal associated with a port under **Excitations** on the project tree. This arrangement is because for network analysis all excitations use the same input signal. However, for composite excitation, each source requires its own time profile. The transient solution setup for composite excitation can be specified for modeling a device that has multiple sources/ports active simultaneously but each port has its own distinct time profile.

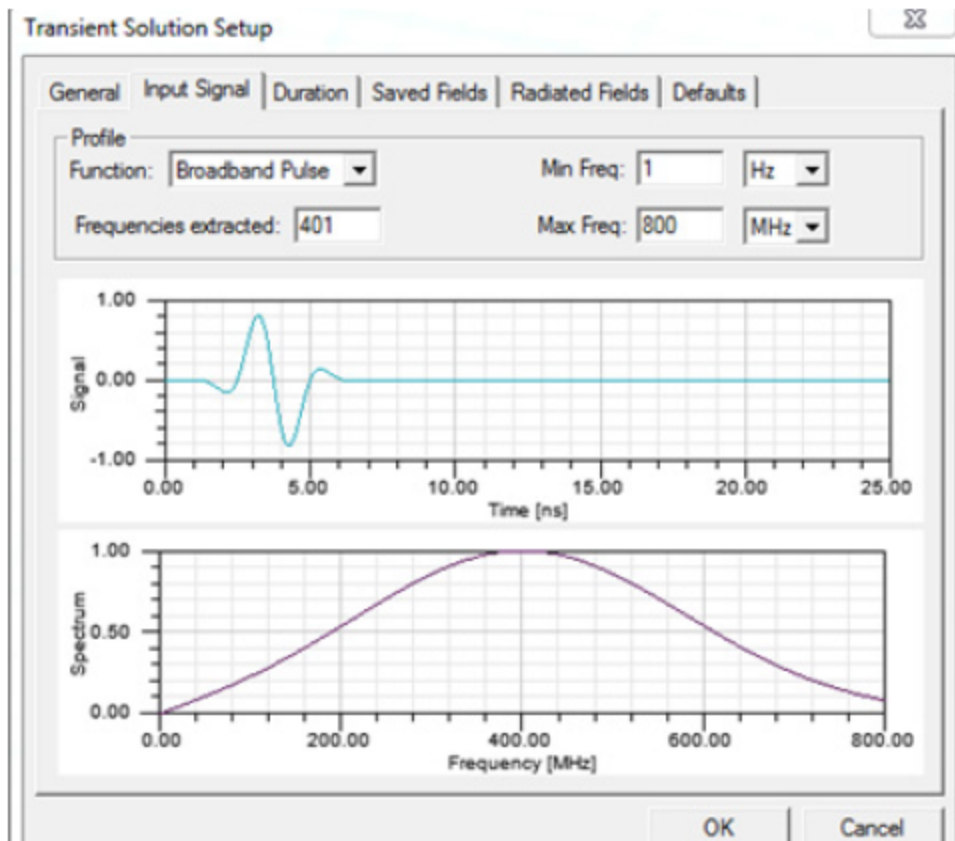

Figure 4-3 Transient Solution Setup For Network Excitations

Some of the options on the **Transient Solution Setup** window for both **Network Excitations** and **Composite Excitations** are described below.

Transient Solver

This panel appears on the **General** tab. You can select either the **Hybrid** solver or the **Implicit** solver depending upon the problem. The hybrid solver is based on the explicit-implicit discontinuous Galerkin time domain method. Implicit solver uses more memory than the Hybrid solver. If you have a graphics processing unit or GPU, you can take advantage of it to speed up simulation. For Hybrid solver GPU acceleration is enabled. When the GPU is enabled, only the explicit part of the hybrid solver is running and being accelerated by GPUs. GPU acceleration in HFSS Transient has been developed for Nvidia cards and is officially supported with the Tesla series. Nvidia Tesla are cards recommended for the best performance when using several cards on one machine to solve either multiple variations or excitations (HPC) in parallel.



Figure 4-4 Graphical Processing Unit can be enabled for Hybrid Solver

Input Signal

On the **Input Signal** tab you can specify the time profile for all sources in the Transient Network analysis. The time profile specifies the pulse used to excite a transient design. You can select either Broadband Pulse or TDR as the profile function. For Broadband pulse, define the minimum and maximum frequencies and number of frequency points to be extracted. This type of pulse excitation is used if you want to extract the S-parameters within a frequency range. Depending upon your minimum and maximum frequencies the upper plot of the signal shows the excitation of interest. The lower plot is the corresponding energy spectrum.

For Time Domain Reflectometry or TDR pulse, the time profile is specified by the rise time which is defined as the time for a pulse signal to rise from 10% to 90% of the peak value. TDR midpoint is the time where the input TDR is at 50% of the peak value. Selecting the **Sync** check box automatically synchronize the signal midpoint and rise time such that minimum allowed midpoint is used for a given rise time or the maximum rise time for a given midpoint. If you clear this check box you can specify a different valid delay. TDR pulse can be used for problems where you want to detect a fault in a transmission line such as a coaxial cable, twisted pair wire etc. or if you want to find discontinuities in signal integrity devices like connectors, printed circuit boards etc.

For Composite excitations, the input signal specifications for exciting a source occur on the **Transient** tab of the **Terminal** dialog box. For each port you must specify a unique time profile. You can select Broadband pulse, harmonic, smooth pulse, or dataset options. Dataset is a

custom time profile. For Broadband pulse in addition to the frequency settings you need to also define the delay and the magnitude of the pulse to excite a port. For Harmonic function displayed as a regular sine wave, define the ramped periods, frequency, delay and magnitude and for smooth pulse, define the pulse width, delay, and magnitude.

Duration

This tab allows you define the stopping criteria for a transient simulation.

Save Fields

You must create object lists and/or face lists for which the transient fields are to be calculated. Save Fields tab allows you to select the list that you want to save the fields for. You can define the start time at which to save the fields, the interval, and the maximum number of samples.

Radiated Fields

On this panel you can save the radiated fields for the frequencies defined on the Input signal tab. Suppose you define a broadband pulse of with a Min and Max frequency of 1 MHz to 200 MHz respectively, and **Frequencies extracted** as 201 on the Input tab, then on the Radiated Fields tab you can save frequency domain radiated fields for the frequency points extracted between 1 MHz to 200 MHz.

HPC and Analysis Options

High performance computing (HPC) enables a range of different technologies in HFSS that allows efficient simulation of extremely large and complex problems. HPC leverages multiple cores through matrix multiprocessing, distributed frequency points (called spectral decomposition method or SDM), domain decomposition (DDM), parallel hybrid FEM/IE solving or the finite antenna array DDM. In addition hierarchical HPC solving is possible where frequency points can be distributed with each frequency point using multiple cores or machines for large scale DDM analysis at each frequency point, all in parallel. HFSS intelligently determines which jobs are to be performed and how to distribute them for the simulation. It automatically apportions the jobs during the simulation process and makes optimum use of the available resources. This computing technology enables generating accurate solutions for large, complex, higher-fidelity models. For example, the following figure illustrates an HFSS solution powered with HPC and Parametrics to solve an antenna on a helicopter launching from stern of a ship. Automatic adaptive meshing provides mesh for each parametric instance.

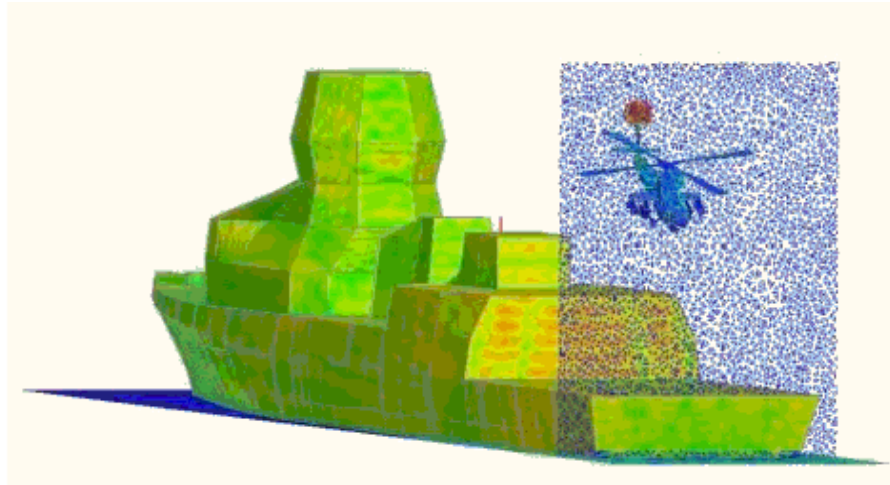

Efficient simulation of large, complex problems by using HPC, HFSS provides enhanced insight that would be difficult or impossible to obtain any other way. HFSS software has these very powerful capabilities that take advantage of multi-core and/or networked computers. These new and enhanced features allow organizations to leverage multi-core/ multi-machine environments and compute clusters. This ability to simulate large, time-consuming problems in a highly efficient manner allows for further, higher-fidelity insight into a company's design.

Domain Decomposition

A unique feature in HFSS is the Domain Decomposition Method that can efficiently and quickly solve large scale electromagnetic problems. In DDM a large problem domain is partitioned into small sub-domains. A large mesh is broken down into small sub-meshes, and each sub-mesh or sub-domain is solved in a separate core or a set of shared cores. These separate cores either reside on a single computer or can be spread across multiple computers in a network. DDM performs the simulation by apportioning the domains across many networked computers or different cores in a single computer. Once simulations are complete, an iterative procedure combines the separate results into a single solution that gives the complete response for the entire model. DDM is extremely scalable with the ability to show in some cases super linear performance with respect to a single core analysis.

For finite periodic structure such as antenna arrays or frequency selective surface the domain decomposition technique is further enhanced by leveraging the repeating nature of the geometry, mesh and matrix. This results in a technique that significantly reduces the memory requirement and simulation time while delivering a comprehensive analysis of the structure including edge effects.

The following figure illustrates a large and complex problem of solving an antenna and its interactions in presence of a vehicle and an full size adult human body using Domain Decomposition Method.

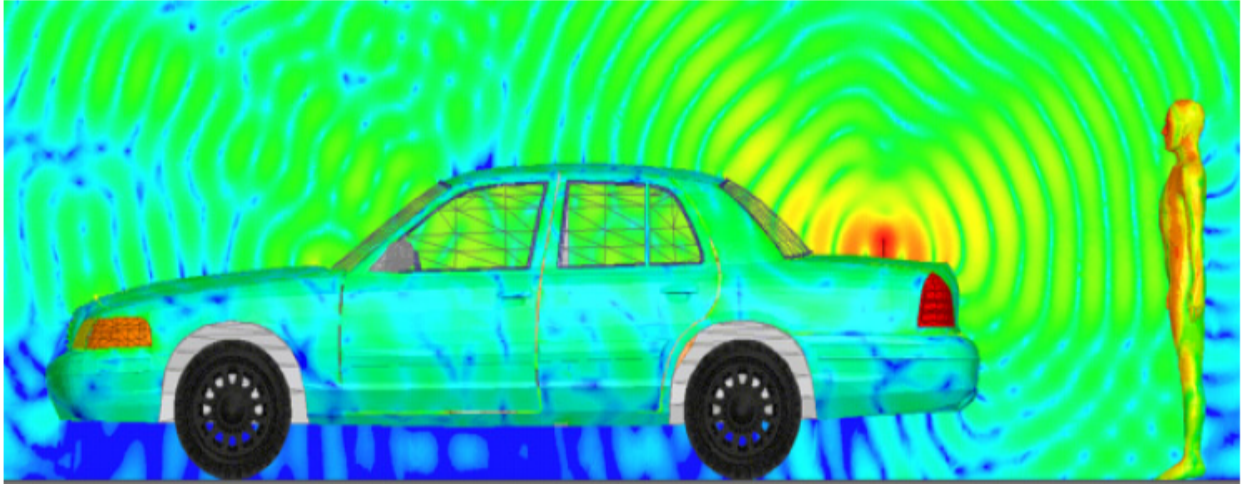

Figure 4-5 Domain Decomposition Method providing large scale electromagnetic solution

The Maximum Number of Passes and Maximum Refinement Per Pass

Refinement percentage and number of adaptive passes are both used in the adaptive solution process. The refinement percentage specifies the largest number of tetrahedra that can be subdivided per adaptive pass.

The maximum number of adaptive passes is the maximum number of times HFSS will refine the mesh in order to try and converge to an answer.

The adaptive solution process uses the delta-S, maximum refinement per pass, and maximum number of passes to converge to the correct answer. The delta-S and maximum number of passes determine when HFSS will stop the adaptive solution process. If convergence is reached before the maximum number of passes has been performed, the solution process stops. HFSS will stop if convergence is not reached, but the maximum number of passes has been reached. In such cases, it is recommended to increase the number of passes so that HFSS can reach convergence.

Frequency Sweeps

HFSS has three sweep types: the discrete sweep, the fast sweep, and the interpolating sweep. Depending on the needs of a user, a particular sweep type may be preferred. Generally, the solution times required for a frequency sweep type increase in the following order: fast, interpolating, and discrete.

For solutions that require field information at only a few (less than five) discrete frequency points, the discrete sweep can be faster than either of the other two.

For solutions that require field information discrete or fast frequency sweeps are used.

The fast sweep is useful when many frequency points are desired over a limited frequency range and it also yields the field information. The interpolating sweep is most useful when solving problems from DC to a high frequency; however, interpolating sweep does not provide field information.

For both the interpolating and fast sweeps, the number of displayed frequency points is not related to the time it takes to generate the frequency sweep results. Both of these sweeps, in essence, generate a pole-zero transfer function, and it is the generation of this function that requires the majority of the solution time. Once the “transfer” function has been generated, S-parameter data is rapidly calculated.

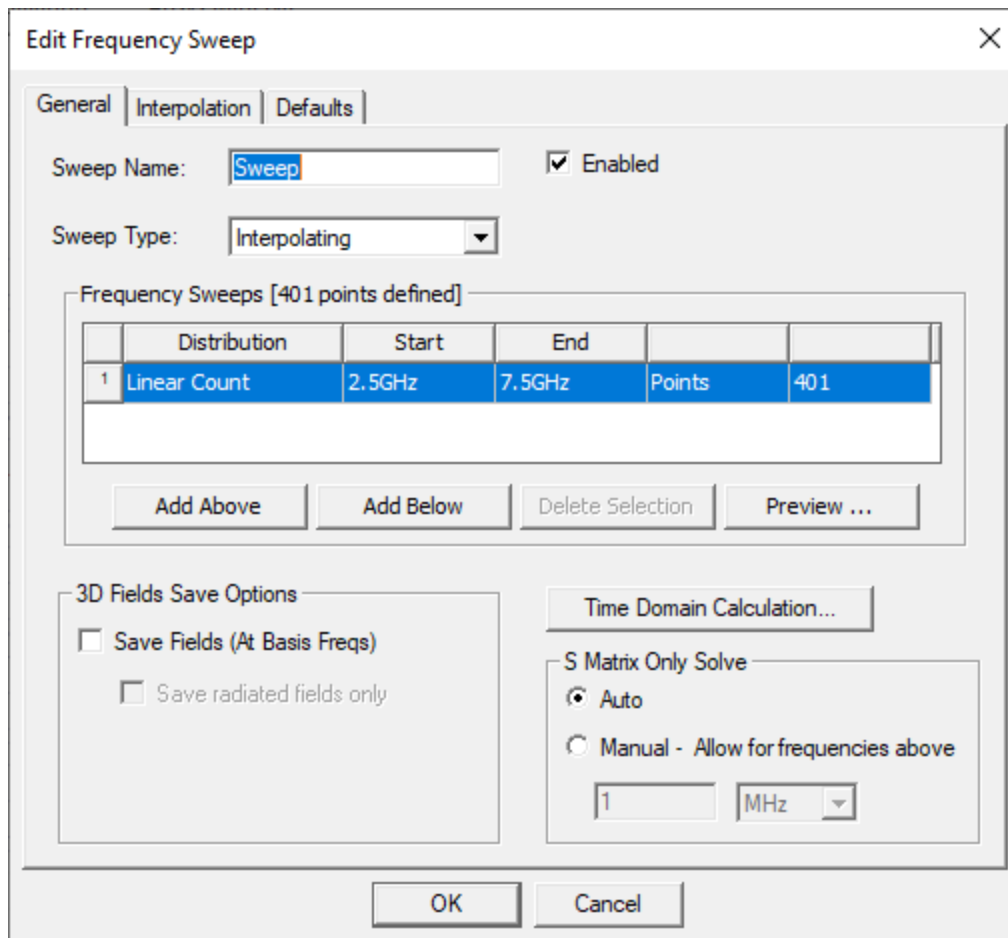

Figure 4-6 Edit Frequency Sweep window

If you use discrete sweep, the field solutions are generated at all the points in the specified frequency sweep. A discrete sweep solution time is directly proportional to the number of frequency points defined in the sweep. Discrete sweep uses the same converged mesh obtained from the adaptive refinement process for solving all frequency points. The results generated by using a discrete sweep are available only those specific points within the sweep.

The *discrete* sweep generates field solutions at specific frequency points in the desired frequency sweep. The discrete sweep solution time is directly dependent on the number of frequency points desired. The more frequency steps a user requests, the longer HFSS needs to complete the frequency sweep. The explicit field solution is obtained by substituting the desired frequencies into the matrix equation that was created during the adaptive solution process. Each frequency solution is therefore explicitly based on the adaptive solution, and not interpolated via a numerical method like the fast and interpolating sweeps. Arguably, therefore, the discrete sweep is the most accurate sweep available. It, however, is also the sweep that requires the most time to generate frequency sweep results when many frequency steps are desired.

Unlike discrete sweep, the fast sweep generates the field solutions for arbitrary points in the specified frequency sweep. If you use fast sweep, the solver determines the frequency points within the defined sweep and creates a reduced order model based on the Eigen values of the problem. The results from a fast sweep are available in arbitrary frequency points due to the interpolating property of the reduced order model. Fast sweep is suitable for problems with sharp resonances. Fast sweeps can accurately determine the electromagnetic behavior of a structure even near resonances.

The *fast* sweep generates a full-field solution within the specified frequency range. The fast sweep is best suited for simulations that have a number of sharp resonances. A fast sweep is highly accurate in determining the behavior of a structure near a resonance.

The fast sweep works by using the center frequency of the sweep to create an Eigen value problem that is used in an Adaptive Lanczos-Padé Sweep (ALPS) procedure to determine all the field solutions in the requested frequency range.

Because the fast sweep uses the results of the adaptive process to generate the Eigen value problem, it is efficient to set the solution frequency to be equal to the center sweep frequency when using the fast sweep.

A key benefit of the fast sweep is that it allows a user to post-process and display fields at any frequency and at any location within the frequency sweep.

The *interpolating* sweep generates a solution for the S-matrix over the defined frequency range. The solver chooses the appropriate frequency points at which the field solution is calculated. HFSS does this by choosing appropriate frequency points at which to solve for the field solution. HFSS continues to choose frequency points until the full sweep solution lies within a given error tolerance.

Similar to the fast sweep the interpolating sweep also creates a reduced order model but just for the SYZ parameters. These parameters are available at arbitrary frequencies.

The interpolating sweep is best suited for very broadband frequency sweeps. The interpolating sweep uses less RAM than a fast sweep. A key benefit of the interpolating sweep is that it can easily determine the frequency sweep response from DC to any desired high frequency. The interpolating sweep, however, has only the solution frequency field data available for post-processing. Field data for other frequencies within the interpolating sweep range are therefore not available.

3D Fields Save Options.

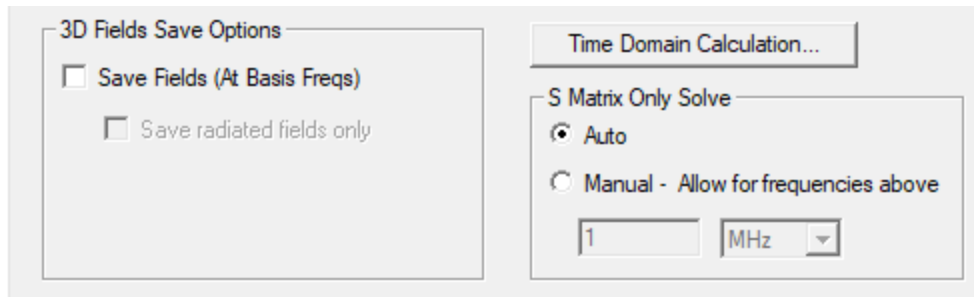

With **Save Fields (At Basis Freqs)** not selected, the default is for **Auto S Matrix Only Solve**. Here, the solver automatically determines threshold of S-matrix only solve. The **Manual** option is available for situations when:

- The direct solver is being used.
If S-matrix only solve has a singularity matrix, you might want to increase the manual threshold.
- If you want faster simulation, you might want to decrease the manual threshold.

Differences between Local, Remote and DSO solutions

A Local Simulation is performed on the local computer (the user's computer).

A Remote Simulation is one where a user does not solve a given HFSS simulation locally. The user sends the simulation to be performed on another computer on the local network.

A DSO, or Distributed Solution Option, is a simulation where a user sends a given HFSS simulation to be solved in parallel on a number of different computers. DSO currently works only for single simulations that have discrete or interpolating sweeps or simulations that use one of the Optimetrics™ features such as parametric sweeps.

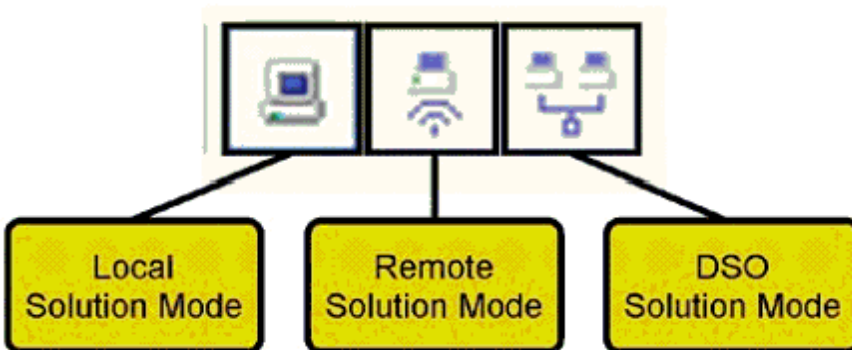

Historically, all HFSS simulations have been local simulations. However, in many enterprise environments, there are select computers that are optimized for maximum RAM, speed, etc. The remote solve capability allows a user to pre- and post-process a given HFSS simulation on the local machine but also have the computationally intensive solution performed on a different, possibly more powerful, computer.

The remote solve capability allows an engineer to still be productive on the local machine doing other tasks, while the intensive number crunching is done on another machine.

The Distributed Solve Option is extremely beneficial for simulations that involve a large number of discrete frequency steps, an interpolating sweep, or for performing a parametric, optimization, statistical, or sensitivity analysis. For the cases of the discrete or interpolating sweep, the required frequency steps are solved in parallel on a number of different computers. If, for instance, a total of 100 discrete frequency steps are desired in a given simulation, DSO can solve all 100 frequency points in parallel provided 100 separate processors are available. This reduces the total simulation time by almost a factor of 100.

For the simulations involving the Optimetrics™ capabilities, the same general concept applies. For instance, if a parametric sweep with 20 variations is desired, the DSO option can take this parametric simulation and solve it in parallel on 20 different computers. Employing the DSO greatly reduces the total computation time required for a parametric simulation.

5 - HFSS Modeling GUI Basics

- ["The HFSS 3D Modeling GUI" below](#)
- ["Modeling Practice in HFSS" on page 5-4](#)
- ["The Various Hotkeys" on page 5-6](#)
- ["Snapping to a Point" on page 5-10](#)
- ["Assigning Boundaries in the GUI" on page 5-11](#)
- ["Assigning Driven Modal Solution Excitations in the GUI" on page 5-13](#)
- ["Assigning Driven Terminal Solution Excitations in the GUI " on page 5-14](#)
- ["Assigning and Creating Materials" on page 5-16](#)
- ["Creating Variables" on page 5-19](#)

The HFSS 3D Modeling GUI

The following illustration shows the HFSS 3D modeling graphical user interface (GUI) of the Ansys Electronics Desktop application and some elements and windows that appear on it. These elements, which include controls and commands, are presented in various graphical forms, such as menus, ribbon tabs, dialog boxes, etc.

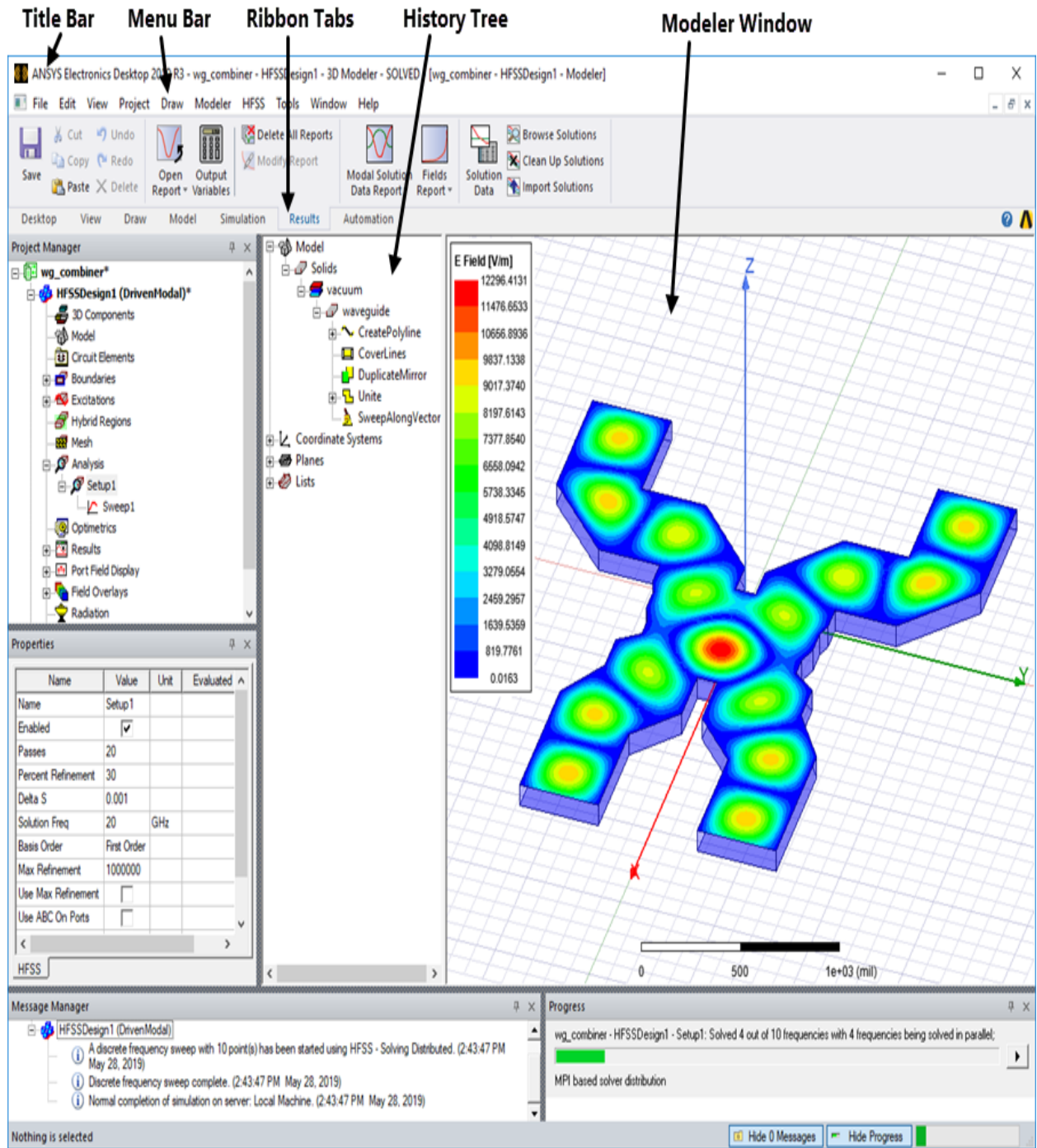

Figure 5-1 HFSS GUI

The Menu Bar is located near the top of the GUI. It consists of a group of menu commands arranged by category such as File, Edit, Project, Draw, Modeler, HFSS, Tools, etc. The Ribbon

contains frequently used commands arranged into Tabs of logically related functions such as View, Draw, Model, Simulation, Results, and more. Commands for all operations in HFSS are accessible from the items and buttons in the menus and ribbon tabs. You can also right-click in the appropriate window or on Project Manager entries to perform desired operations.

For example, to excite a design with a wave port, select the appropriate face on the design, click the **HFSS** menu, go to **Excitations > Assign >** and click **Wave Port**. This command brings up the wave port wizard where you can enter the settings to apply the wave port excitation.

Alternatively, select the appropriate face on the design, right-click in the *Modeler* window, select **Assign Excitation** and click **Wave Port** from the shortcut menu.

There are six distinct windows that can be active within the HFSS GUI:

- Project Manager
- History Tree
- Modeler
- Properties
- Message Manager
- Progress

Each of the windows serves a unique purpose during the creation and simulation of a given HFSS design.

3D Modeler Window

On the 3D Modeler, you can create the objects to be simulated. Depending upon the type of object you can select a basic solid, sheet, or line type from the Quick Access toolbar or from the available commands under the **Draw** menu item. For example, to create a box with the grid plane XY being active perform these simple steps:

1. Select the **Draw box** command from the Quick Access toolbar.
2. Click anywhere in the modeler window to create a point, drag the cursor along the XY plane and click again to create the point diagonally opposite to the first point.
3. Drag the cursor along the Z axis and click again to create the box.
4. Select **CreateBox** in the History tree and edit the fields on the Properties window to specify the coordinates, and the dimensions of the box.

Properties Window

The *properties window* displays the properties of an object or an option that is selected in the 3D Modeler window, History tree, or Project Manager. For instance if you select a box object in the 3D Modeler window the Properties window displays the attributes of the box object such as its name, material, color etc.

Project Manager Window

The *Project Manager* window serves as an important command and project organization window, helping you to manage your simulation designs and setups. All pertinent preprocessing and solution information is displayed within this window (such as boundaries, excitations, solution setup, frequency sweep, mesh settings, 3D components, and more). Information about various Optimetrics setups appears here. Finally, all post-processing items, such as results plots, field overlays, and antenna setup are also contained in the *Project Manager* window.

History Tree

The *history tree* window contains the model's structure and grid details. History of the operations on a geometry right from creating it, performing Boolean operations etc are recorded in this window. It displays a number of items such as solids, sheets, lines, points, coordinate systems, planes, Lists, 3D components etc one below the other.

Message window

The *message window* displays all messages pertinent to a simulation. They can be warning messages, error messages, or messages that notify normal completion of a simulation.

Progress window

The *progress window* displays the progress of a given simulation being performed on the local machine, on a remote machine, or on a distributed network of machines using the Distributed Solve Option available with HFSS. It displays the number and information about an adaptive pass that is running. It also displays information about a frequency sweep that is running.

Modeling Practice in HFSS

Typical modeling practice of creating and simulating a 3D model in HFSS involves the following steps:

1. Create model/geometry
2. Assign boundaries
3. Assign excitations
4. Assign solution setup
5. Validate and analyze
6. Perform post-processing operations

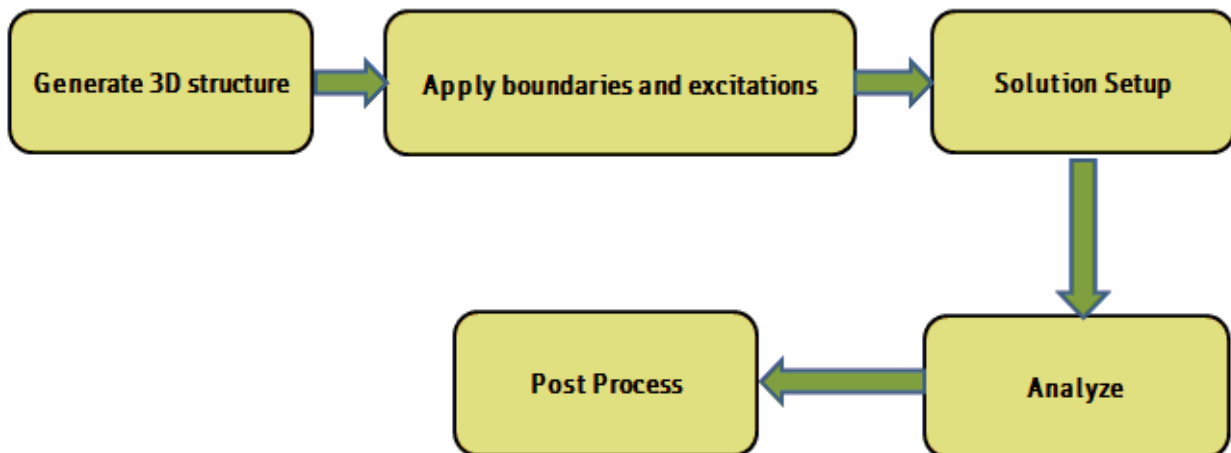

Figure 5-2 Modeling Practice in HFSS

Every HFSS simulation involves, to some degree, all six of the above steps. It is not mandatory to follow these steps in the exact order, however, they constitute a good modeling practice.

The steps are described here.

1. Create Geometry

On the 3D Modeler, create the geometrical model that you want to analyze. The 3D modeler in HFSS has advanced features that enable you to parameterize a structure by creating variables and assigning values to them while defining geometric dimensions and material properties. A parameterized structure is very useful especially, when the final dimensions are not known or when the design needs to be modified for performance improvements.

You can also import 3D structures from mechanical drawing packages, such as SolidWorks®, Pro/E® or AutoCAD®. However, imported structures do not retain any history of how they were created so they will not be parameterizable upon import. You must manually modify an imported geometry, if you want to parameterize the structure.

2. Assign Boundaries

Assign boundary conditions in the next step. Boundaries are defined on 2D (sheet) objects specifically created for this purpose or on surfaces of 3D objects. Boundaries have a direct impact on the generated solutions. Depending upon the problem, HFSS offers different types of boundary conditions including Perfect E, Perfect H, Radiation, Primary, Secondary, Impedance, Finite Conductivity, PML, Layered Impedance, Anisotropic Impedance, and Lumped RLC.

Note: For more information about boundary conditions, see the chapter *Assigning Boundaries in HFSS* in the ANSYS Electronics Desktop help.

3. Assign Excitations

Excite the geometry by assigning excitations. Excitations are sources of electromagnetic fields in the design. HFSS has various options to generate incident fields that interact with a structure to produce the total fields. Some of these excitations are local sources residing within the structure such as wave ports and voltage sources while other excitations such as plane waves are created from local sources away from the structure. Excitations available in HFSS include wave port, lumped port, terminal, Floquet ports, incident wave, voltage source, current source, magnetic bias. There are several convenient rules that you can follow for proper creation and use of excitations to obtain highly accurate results in HFSS.

Note: For more information about excitations and the guidelines for defining them, see the chapter Assigning Excitations for HFSS in the Ansys Electronics Desktop help.

4. Assign Solution Setup

The next step is to create a solution setup. In this step, specify a solution frequency, the desired convergence criteria which include the maximum number of adaptive passes and the magnitude of maximum delta S. To generate a solution across a range of frequencies, define a frequency sweep.

5. Validate and Analyze

After performing the above four steps, the model can be validated and then analyzed if it passes the validation check. The time required for an analysis depends upon the model geometry, the solution frequency, and available computer resources. HFSS also comes with advanced High Performance Computing capability for accelerated performance and for solving large problems.

6. Post Processing

Perform post processing once the simulation runs to completion. Any field quantity or S,Y,Z parameter can be plotted in the post-processor. Additionally, if a parameterized model has been analyzed, families of curves can be created. For example, you can examine the S-parameters of the device modeled, far fields created by an antenna, or plot the electromagnetic fields in and around the structure.

The Various Hotkeys

A hotkey is a specific key, or combination of keys, that you can press to perform a task more quickly than by using the mouse. For example, if you want to fit the extents of a model within the 3D Modeler window, simply press **Ctrl + D**. This hotkey combination is quicker than navigating the View menu or locating a command on a ribbon tab, especially if your hands are already on the keyboard.

Common hot keys, often in conjunction with a mouse button, are used to perform pan, rotate, and zoom operations. Additionally, you can use hotkeys to produce standard planar (XY, YZ, XZ) and isometric views of geometry in the modeling window.

To **pan** the view, press **Ctrl + middle-click** and drag the mouse. Alternatively, if the *Enable Legacy View Navigation* option is selected in the [User Interface Options](#), you can also press **Shift + left-click** and drag to pan the view.

To **rotate** the view press middle-click and drag the mouse. Alternatively, if the *Enable Legacy View Navigation* option is selected in the [User Interface Options](#), you can also press **Alt + left-click** to rotate the view.

To **zoom** the view, middle-click and drag the mouse upward (zoom in) or downward (zoom out). Alternatively, if the *Enable Legacy View Navigation* option is selected in the [User Interface Options](#), you can also press **Alt + Shift + left-click** and drag upward/downward to zoom the view in/out.

Holding down the **Alt** key while double-clicking the left mouse button orients the view in the Modeler window as shown in the figure below. The resulting view orientation depends on which of the nine zones the cursor occupies when you double-click. Each cube in the figure represents a clicking zone and shows the resulting view orientation:

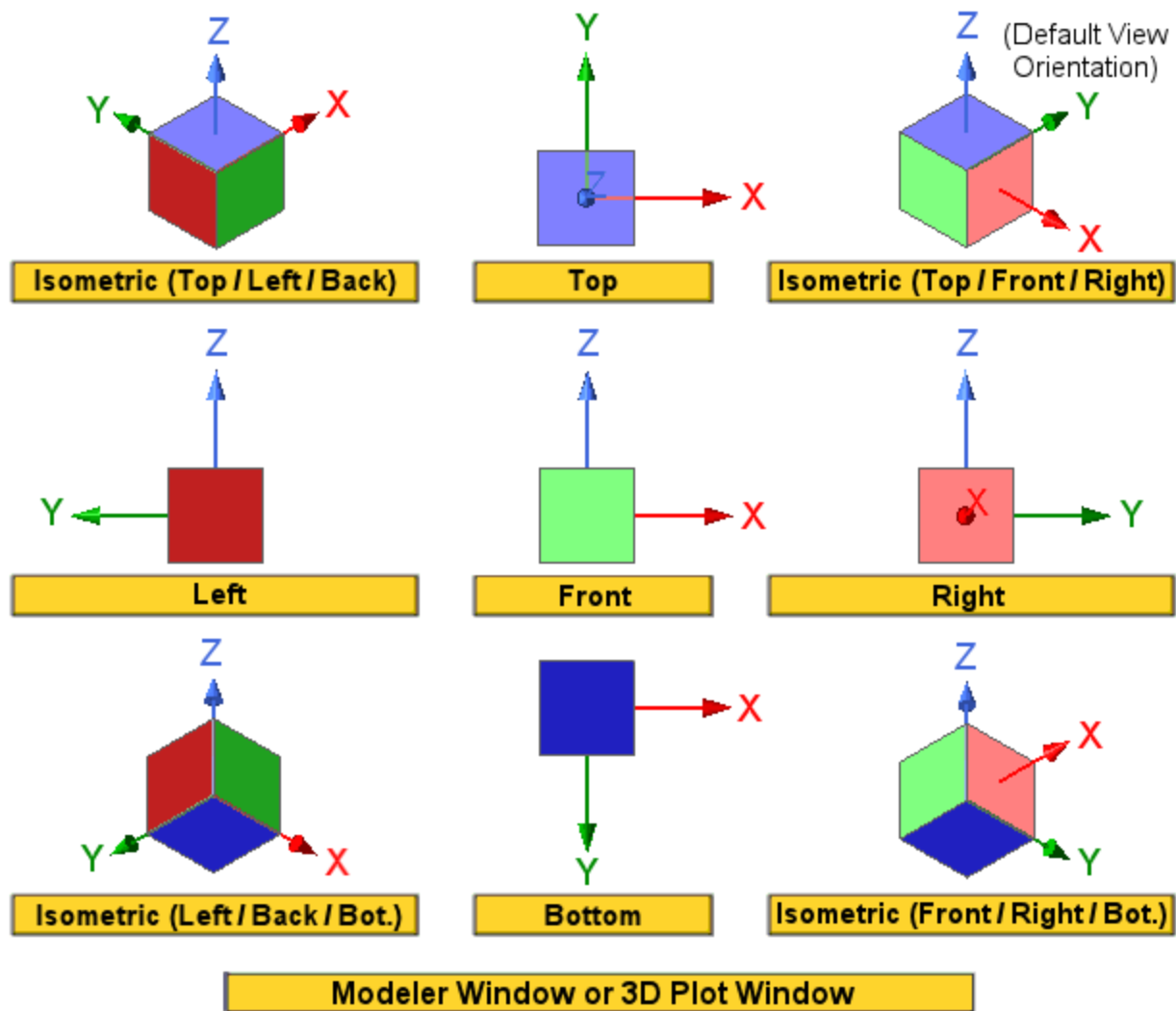

There is no Alt + double-click zone associated with the standard *Back*, *Dimetric*, or *Trimetric* view orientations. These three views must be selected from available menu or ribbon commands.

There are a number of additional hotkeys. They are broken down into two groups: *General Hotkeys* and *3D Modeler Hotkeys*, which are discussed in the next two topics.

General Hotkeys

F1	Help (context-sensitive)
F2	Rename an item in the <i>Project Mmanager</i> window.

F4 + CTRL	Close Modeler
CTRL + C	Copy
CTRL + N	New Project
CTRL + O	Open
CTRL + S	Save
CTRL + P	Print
CTRL + V	Paste
CTRL + X	Cut
CTRL + Y	Redo
CTRL + Z	Undo
CTRL + 0	Cascade windows
CTRL + 1	Tile windows horizontally
CTRL + 2	Tile windows vertically

3D Modeler Hotkeys

B	Select face/object behind current selection
F	Face selection mode
O	Object selection mode
E	Edge selection mode
V	Vertex selection mode
U	Sub model selection mode
M	Multi-selection mode (for example, to select an edge and a vertex)
CTRL + A	Select all visible objects
CTRL + SHIFT + A	Deselect all objects
CTRL + D	Fit view
SHIFT + Middle Mouse Button	Pan the view

SHIFT + Left Mouse Button	Pan the view This combination only works if the <i>Use Legacy View Navigation</i> option is selected in the User Interface Options .
CTRL + arrow-keys	Pan the view vertically or horizontally. Each press of an arrow key pans the view 10 screen pixels.
Middle Mouse Button	Rotate the view
ALT + arrow-keys	Rotate the view about a vertical or horizontal axis. Each press of an arrow key rotates the view 2.5°
ALT + Left Mouse Button	Rotate the view This combination only works if the <i>Use Legacy View Navigation</i> option is selected in the User Interface Options .
CTRL + "+"	Zoom in, screen center
CTRL + "-"	Zoom out, screen center
SHIFT + Middle Mouse Button	Zoom in/out – drag upward to zoom in and downward to zoom out
ALT + SHIFT + Left Mouse Button	Zoom in/out – drag upward to zoom in and downward to zoom out This combination only works if the <i>Use Legacy View Navigation</i> option is selected in the User Interface Options .
F3	Switch to point entry mode (that is, draw objects by mouse)
F4	Switch to dialog entry mode (that is, draw object solely by entry in command and attributes box)
F6	Render model wire frame
F7	Render model smooth shaded

Snapping to a Point

The HFSS modeling UI employs a visual feedback system that allows you to “snap” to a particular location on an object. The cursor changes shape when it is moved over a specific location, thus indicating that any drawing object created will be snapped to that specific location.

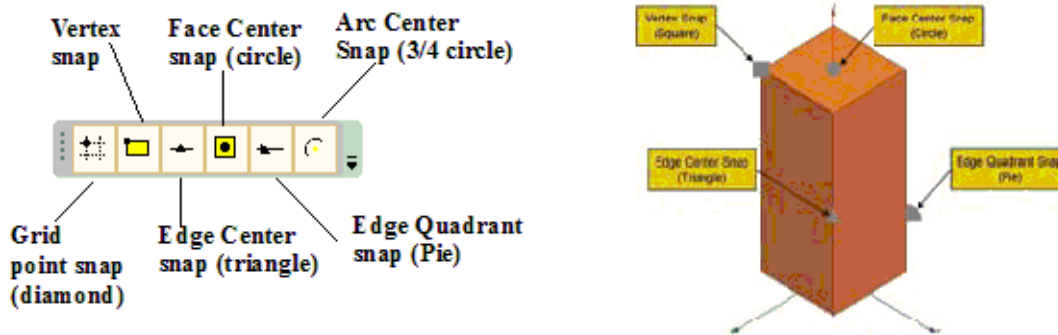

Figure 5-3 Simple 3D object showing various “snap” locations and the location-specific icon.

By default, the selection point and graphical objects are set to “snap to,” or adhere to, a point on the grid when the cursor hovers over it. The coordinates of this point are used, rather than the exact location of the mouse. The cursor changes to the shape of the snap mode when it is being snapped.

The cursor in the HFSS modeling UI is usually a small diamond. However, the diamond shape changes into a circle, triangle, pie slice, or rectangle, depending on whether the cursor is moved into close proximity with a face center, mid edge, quarter edge, or corner vertex, respectively. Once the cursor has changed shape, a drawing object is “snapped” to the location that corresponds to the cursor shape. For example, if you want to draw a cylinder that is centered on a face of a cube, simply move the cursor over the center of the face until the cursor changes to a circle. Once it has changed shape to a circle, click to set the start location of the cylinder and the cylinder center will be snapped to the center of the cube face.

You can follow the above procedure and snap to any convenient point when creating any model objects.

Snap locations can be activated and deactivated at your discretion. To do this, a user can simply select which snap to have active by selecting the appropriate icon. Alternatively, a user can vary the snap selection by selecting modeler in the tool bar and choosing snap mode.

Assigning Boundaries in the GUI

Boundaries are assigned to 2D object in a model or on the surfaces of 3D objects.

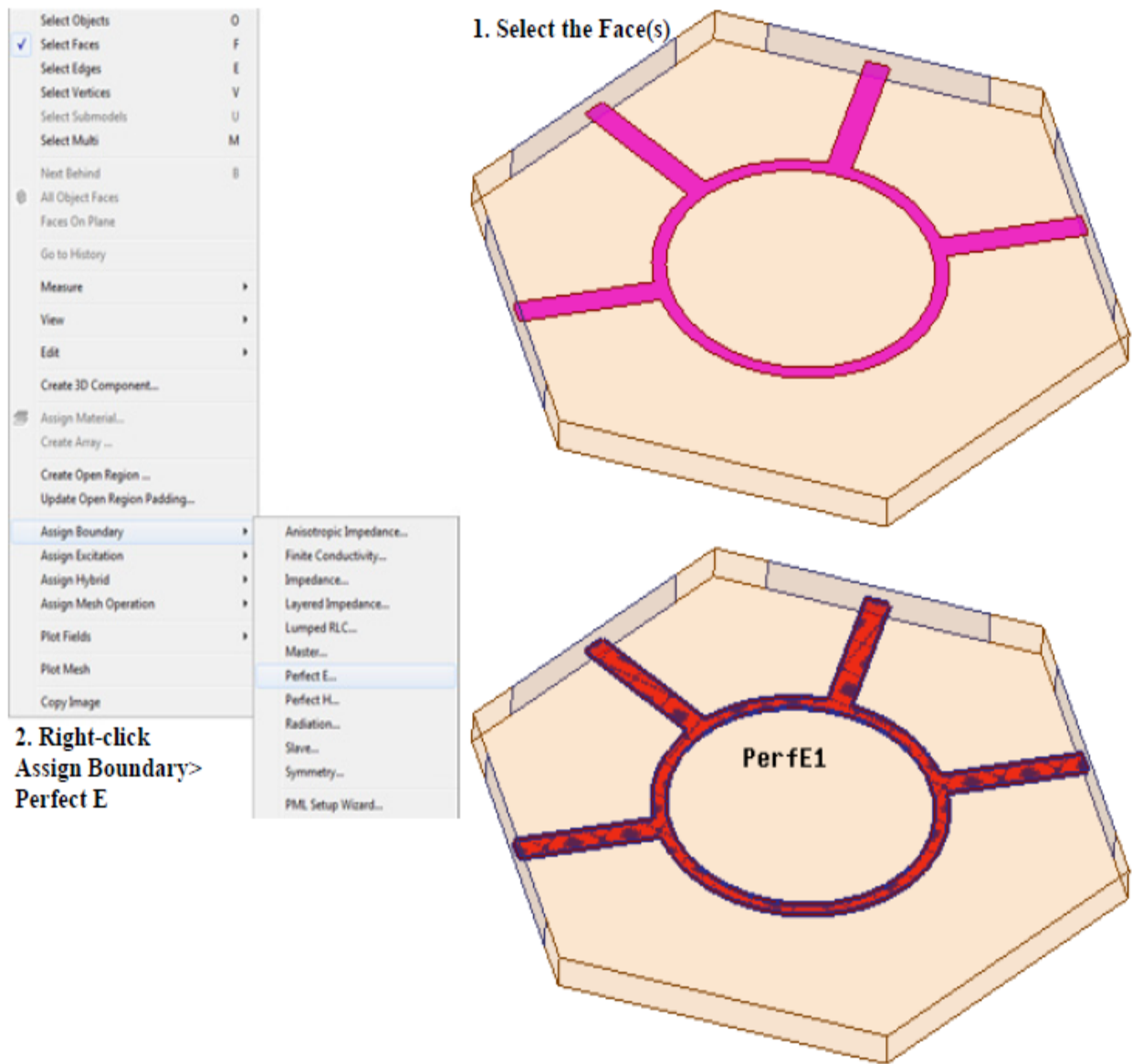

Figure 5-4 Perfect E Boundary assignment

To assign a boundary to a 2D object or 3D face, press the F key to enter face selection mode and select the appropriate 2D object or 3D face. Once all the desired faces have been selected, simply right-click and select **Assign Boundary**. Finally, select the desired boundary. Alternatively, once all the faces have been selected, a user can click the menu item **HFSS** near the top and go to **Boundaries > Assign >** and select the desired boundary.

Note: If you want to assign a common boundary to multiple faces, first select the multiple faces by holding the CTRL key and in the same way assign the boundary.

Assigning Driven Modal Solution Excitations in the GUI

Excitations are assigned to 2D object in an HFSS model or on the surfaces of 3D objects. You can assign appropriate excitations on a design based on the solution type. The steps for assigning wave ports for a driven modal project are shown below.

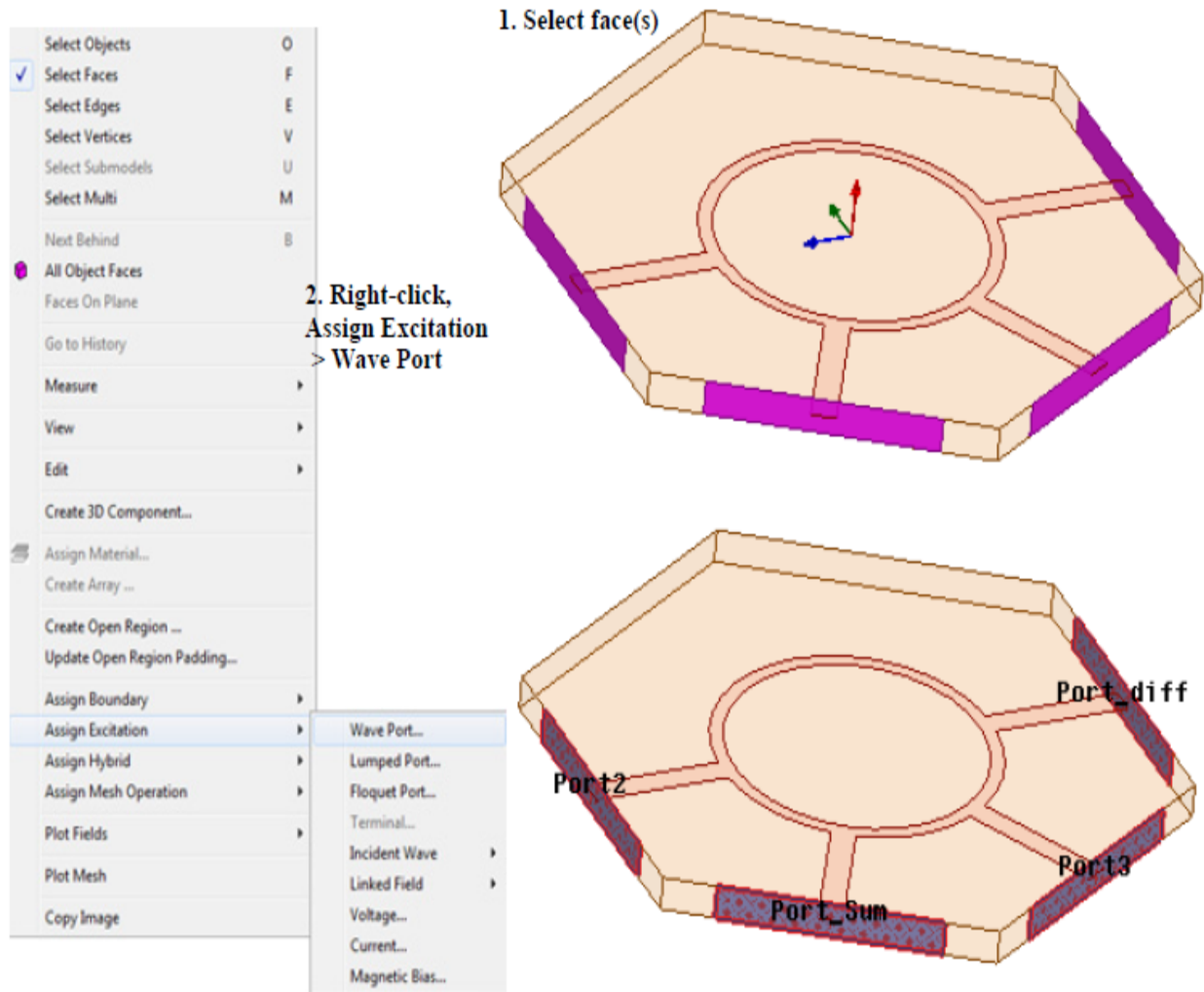

Figure 5-5 Wave Port assignment for a modal project

To assign an excitation to a 2D object or 3D face, press F to enter face selection mode and select the appropriate 2D object or 3D face. Multiple faces can be selected if a common excitation is to be applied to them. Once all the desired faces have been selected, right-click and go to select **Assign Excitation** and click the desired excitation from the submenu. Alternatively,

select all the faces and click the **HFSS** menu item on the menu bar near the top, and go to **Excitations > Assign >** and click the desired excitation on the submenu.

A user should ensure that the port area is of the proper dimension. For reference, see the section on ports. While it is not necessary to create an integration line when creating a wave port, it is good modeling practice and is, therefore, strongly encouraged.

Assigning Driven Terminal Solution Excitations in the GUI

Excitations are assigned to specifically created 2D object in an HFSS model or to specific faces of 3D objects. To assign an excitation to a 2D object or 3D face, simply change to the select faces mode and select the appropriate 2D object or 3D face. Multiple faces can be selected if a common excitation is to be applied to them. Once all the desired faces have been selected, right-click, select **Assign Excitations**, and choose the desired excitation. Alternatively, once all the faces have been selected, you can click on HFSS in the top-level menu bar, select excitations, choose assign, and select the desired excitation.

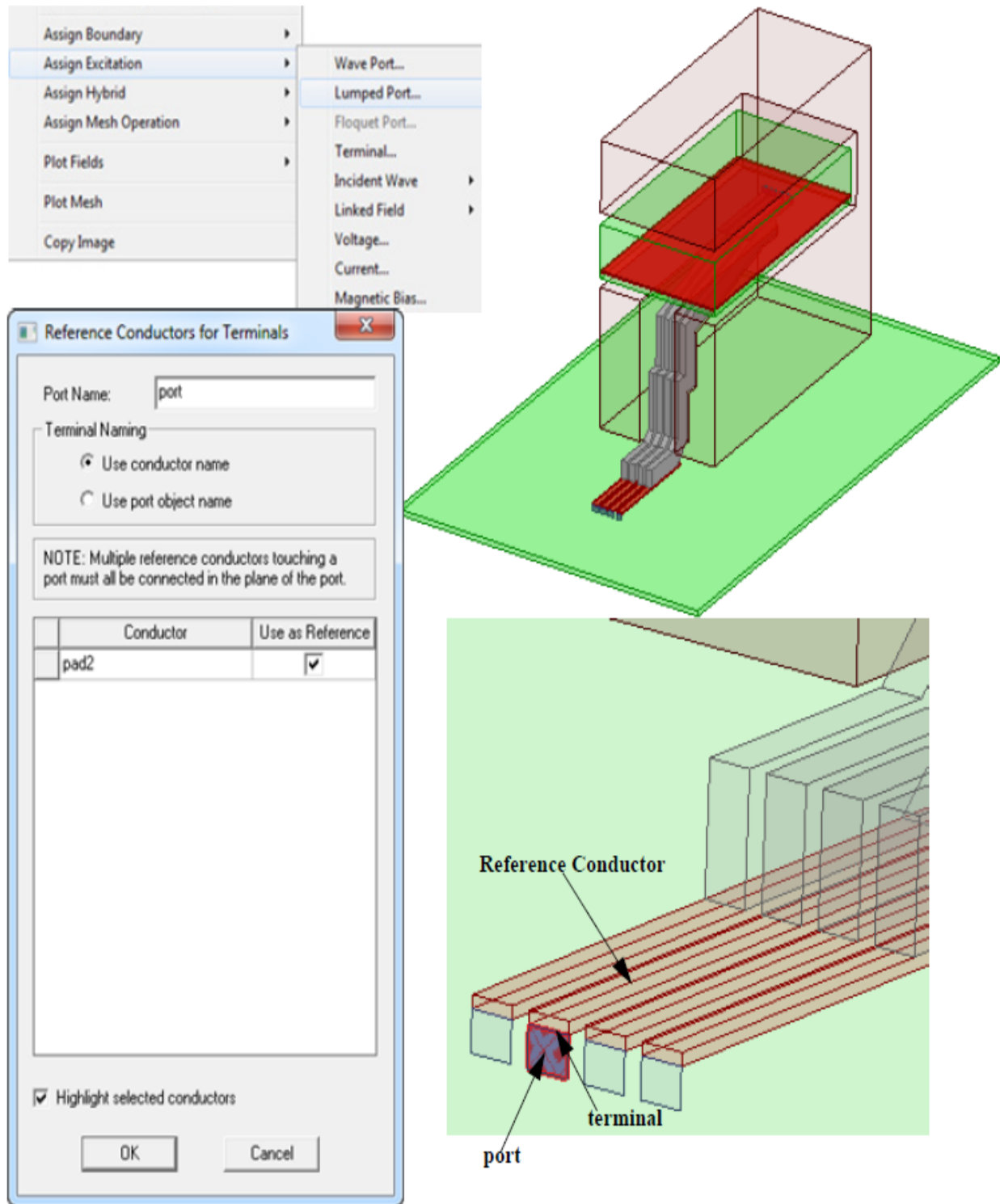

Figure 5-6 Terminal Solution Excitations on a Connector

HFSS can automatically associate terminals with the ports whether you assign the ports first and then define the terminals or vice versa. You can define terminals from the **Excitations** level (in the Project Manager window) when the ports already exist. Regardless of the order in which they are assigned, a terminal is associated with the port containing the signal and reference conductors that define the terminal.

Assigning and Creating Materials

All 3D objects in HFSS can have a material property assigned to them. Objects are assigned a default material during the 3D object creation process. The material assigned to a given object can be changed at any time after the object is created.

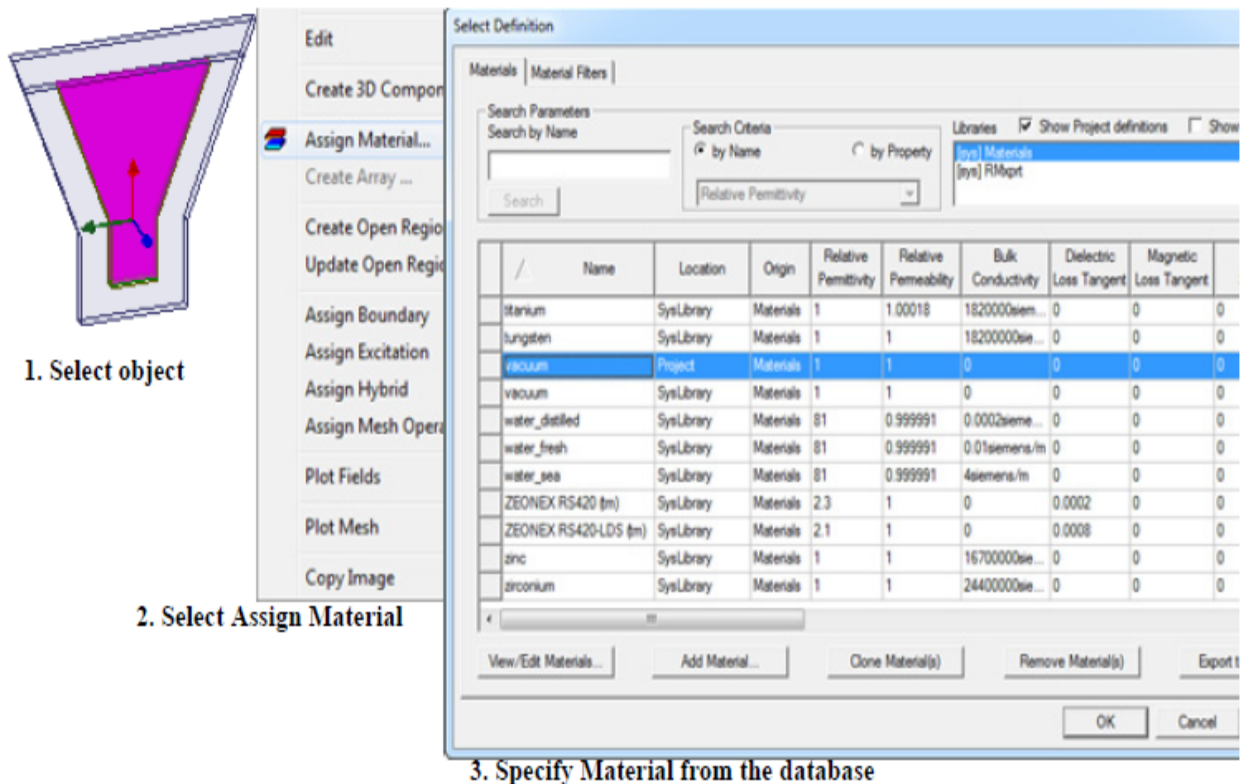

Figure 5-7 Material Assignment process

You can also define or change the material property of an object, from the **Edit Libraries** window. To bring up this window, go to the **Tools** menu and select the **Edit Libraries > Materials**. Select the material from the database and click OK to assign the desired material on the object.

There are other methods to assign materials. After you create an object the **Properties** window appears. The **Properties** window is also docked with the **Project Manager** window. Upon creation of a new object, go to the **Attribute** tab on the Properties window. From the **Materials** drop-down menu select **Edit** and open the **Select Definition** window and specify the desired material from the database.

If you double-click the object name in the command history tree, the Attribute dialog box appears where you can change the material.

If a particular material is not found in the default HFSS material database, a custom material can be created. Frequency-dependent material can also be created if needed.

To add a material to the database, simply access the materials database and click on the Add Material button at the bottom of the dialog box. Simply enter a name along with the desired material properties and close the dialog by clicking OK. The created material is automatically assigned to the 3D object.

Frequency-dependent materials can be based on four distinct definitions: Piecewise-linear, Debye, Djordjevic-Sarkar, or as a collection of data points. Each method creates a material that has specific material properties as a function of frequency.

The *Piecewise Linear* and Frequency-Dependent Data Points models apply to both the electric and magnetic properties of the material. However, they do not guarantee that the material satisfies causality conditions, and so they should be used only for frequency-domain applications.

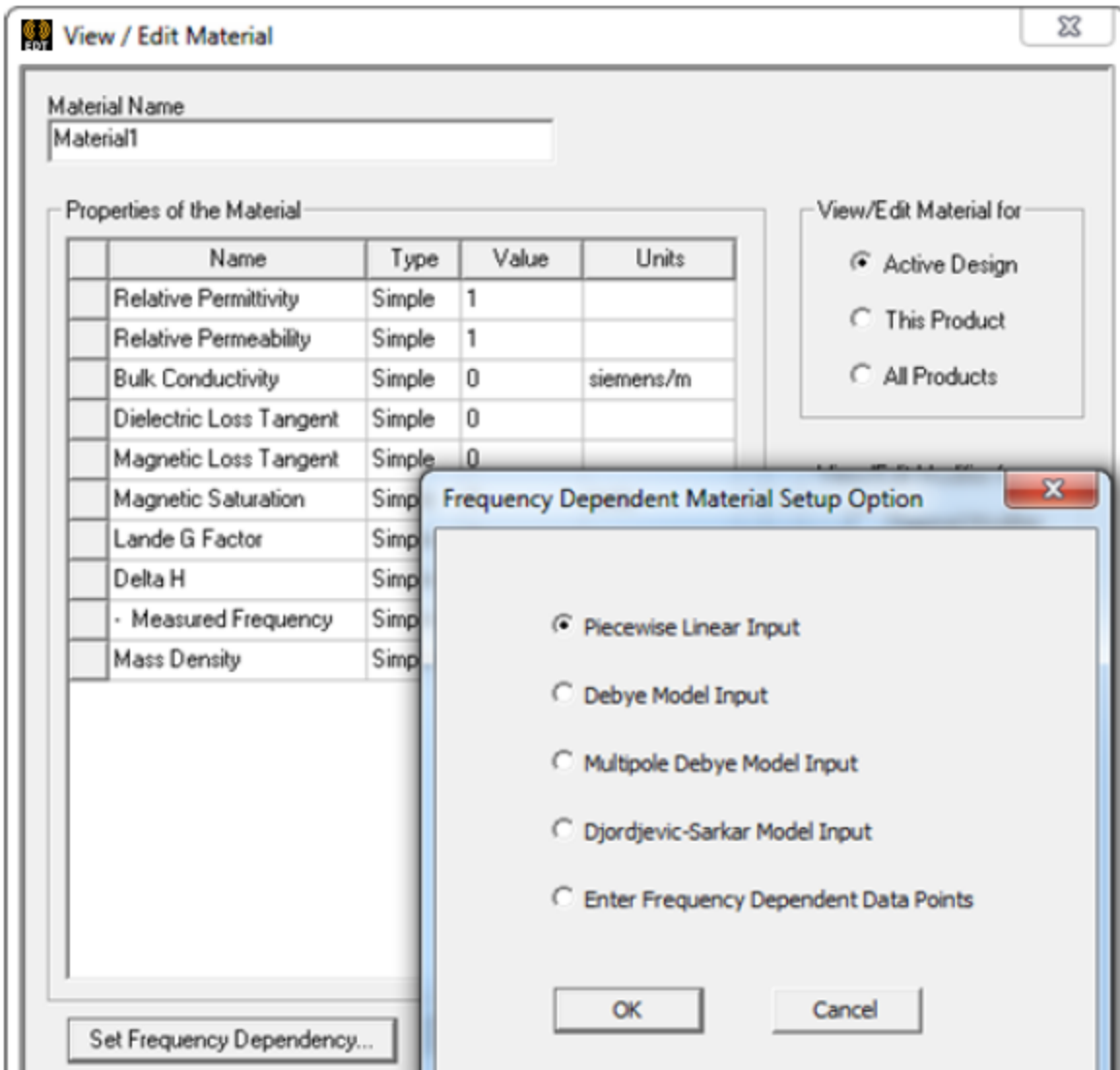

Figure 5-8 Custom material creation

The Piecewise linear model defines a material that has three distinct regions. The first region has a flat constant dielectric property, the second has a linear slope, and the last section is flat again. You can specify the break frequencies between sections one and two and sections two and three.

The Debye and Djordjevic-Sarkar models apply only to the electrical properties of dielectric materials. These models satisfy the Kramers-Kronig conditions for causality, and are preferred for applications where HFSS results, both S-parameter and equivalent circuit, will be used in a time-domain simulation.

The *Debye* model is a single pole model for the frequency dependency of a lossy dielectric. You can specify the two frequencies along with the dielectric constant and loss tangent at those frequencies. If desired, you can also specify the permittivity at an optical frequency and DC conductivity and constant relative permeability.

For the *Djordjevic-Sarkar* model, you can specify the permittivity and loss tangent at a single frequency. Additionally, you may enter the conductivity and permittivity at DC. This model was specifically developed for materials that are commonly used in printed circuit board and package designs.

Creating Variables

You can create variables for any dimensional or material property, or output value. Variables can be Design variables or Project variables. Once a variable has been created, parametric sweeps, optimization, sensitivity and statistical analysis can be performed.

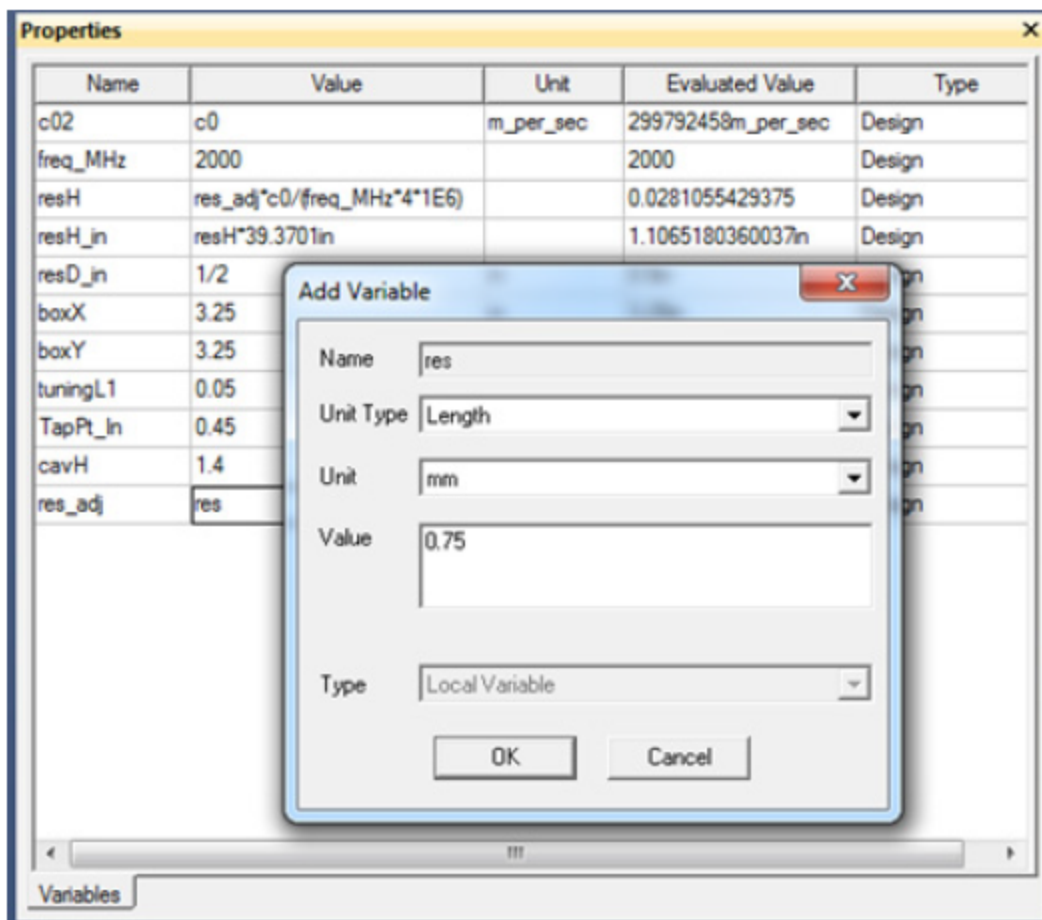

Figure 5-9 Variable Creation

When you specify a variable in the Properties window for a particular dimension the Add Variable dialog appears. In this dialog you can define the **Value**, **Unit**, and the **Unit Type** for the variable.

You can also define variable as you create the object. For example, suppose you want to create a box and variables for the length, breadth, and height of the box. To do this, enter the variable name for the different dimensions. For each variable name you enter, the Add Variable dialog box appears prompting you to specify a value for the defined variable.

There are two types of variables in HFSS: design variables and project variables. *Project variables* can be assigned to any parameter value within the HFSS project where it was created. By contrast, *design variables* can be assigned only to a parameter value within the design where it was created. A project may contain many designs, so depending on how often a variable is used and where you can determine what type of variable to use.

Regardless of the type of variable, it always represents a numerical value, mathematical expression, or mathematical function that can be assigned to a design parameter in HFSS. Variables are very useful in situations where a parameter value is changed often, if it is desired to perform a parametric analysis, perform an optimization, or intend to create an output variable to which HFSS is desired to converge to.

6 - HFSS Post-Processing

- ["Plotting S-parameter results" below](#)
- ["Exporting Touchstone Files" on page 6-3](#)
- ["Advanced Plotting of Results" on page 6-5](#)
- ["Plotting Antenna Results" on page 6-6](#)
- ["Plotting Field Results" on page 6-8](#)
- ["Creating Animations" on page 6-10](#)

Plotting S-parameter results

One of the most important outputs from HFSS is the S-parameter. Once a simulation has finished, S-parameters can be plotted at a single frequency or over a frequency sweep.

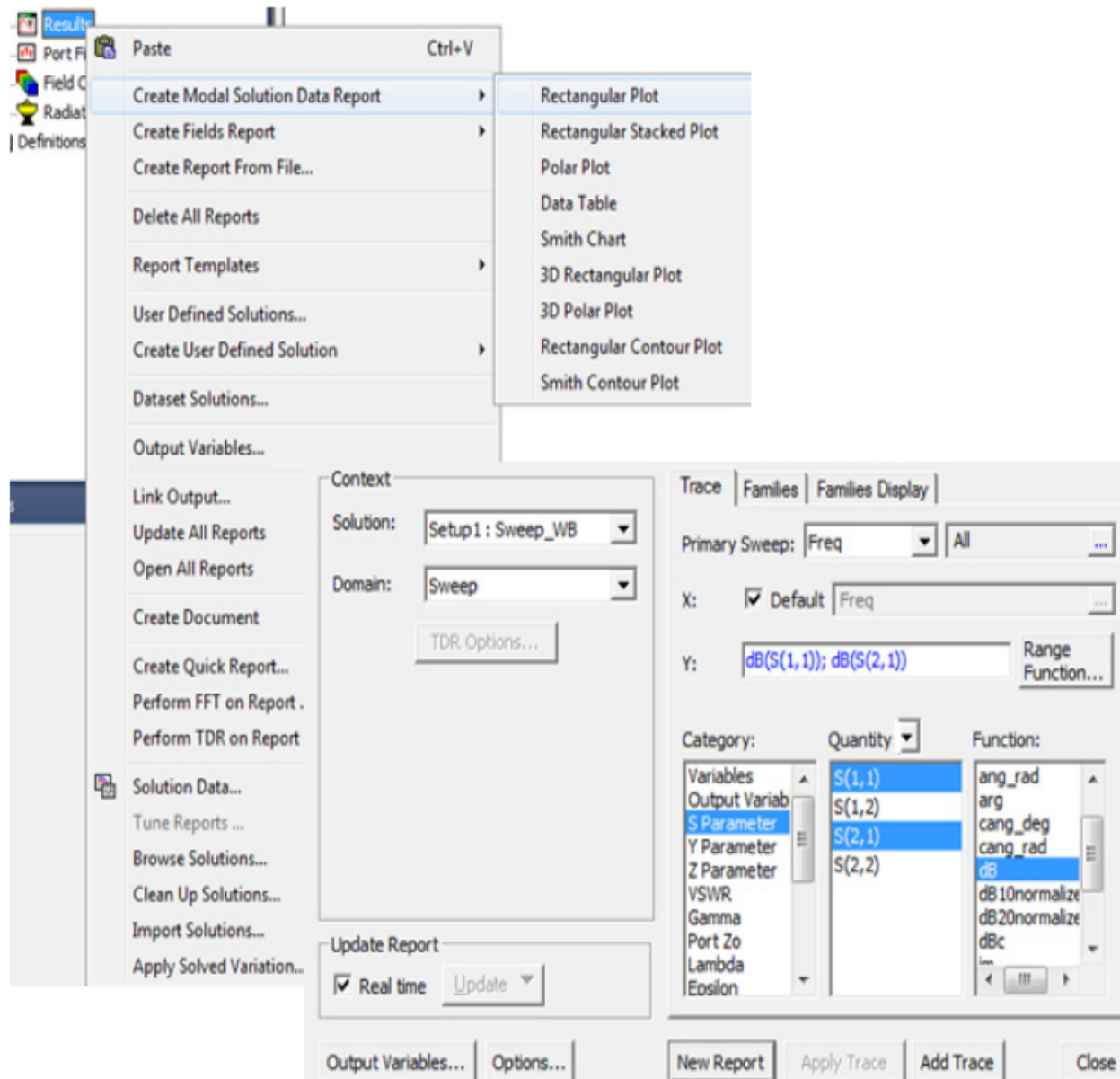

Figure 6-1 Creation of S-parameter plots

To create an S-parameter plot, right-click **Reports** on the **Project manager** window and select the option **Create Modal Solution Data Report > Rectangular Plot**. This command opens the Report dialog box. Select the desired Solution under the Context panel and then from the Category, Quantity, and Function panels, select the S-data to be plotted.

HFSS generates S-parameters with matched loads. Matched load essentially means that the port is loaded by its characteristic port impedance. S-parameters of the matched loads can be renormalized by loading the ports with arbitrary impedance. When comparing HFSS wave port

results to measured data, it is important to re-normalize the HFSS results to the loading impedances when the measurement was performed. If a given S-parameter is based on a lumped port, the S-parameters are normalized to the value of Z_0 specified when the port was created.

Exporting Touchstone Files

HFSS allows exportation of any of the quantities that it calculates in touchstone format. A common use of exported touchstone files is in circuit simulators. Touchstone files are easily exported by following the steps.

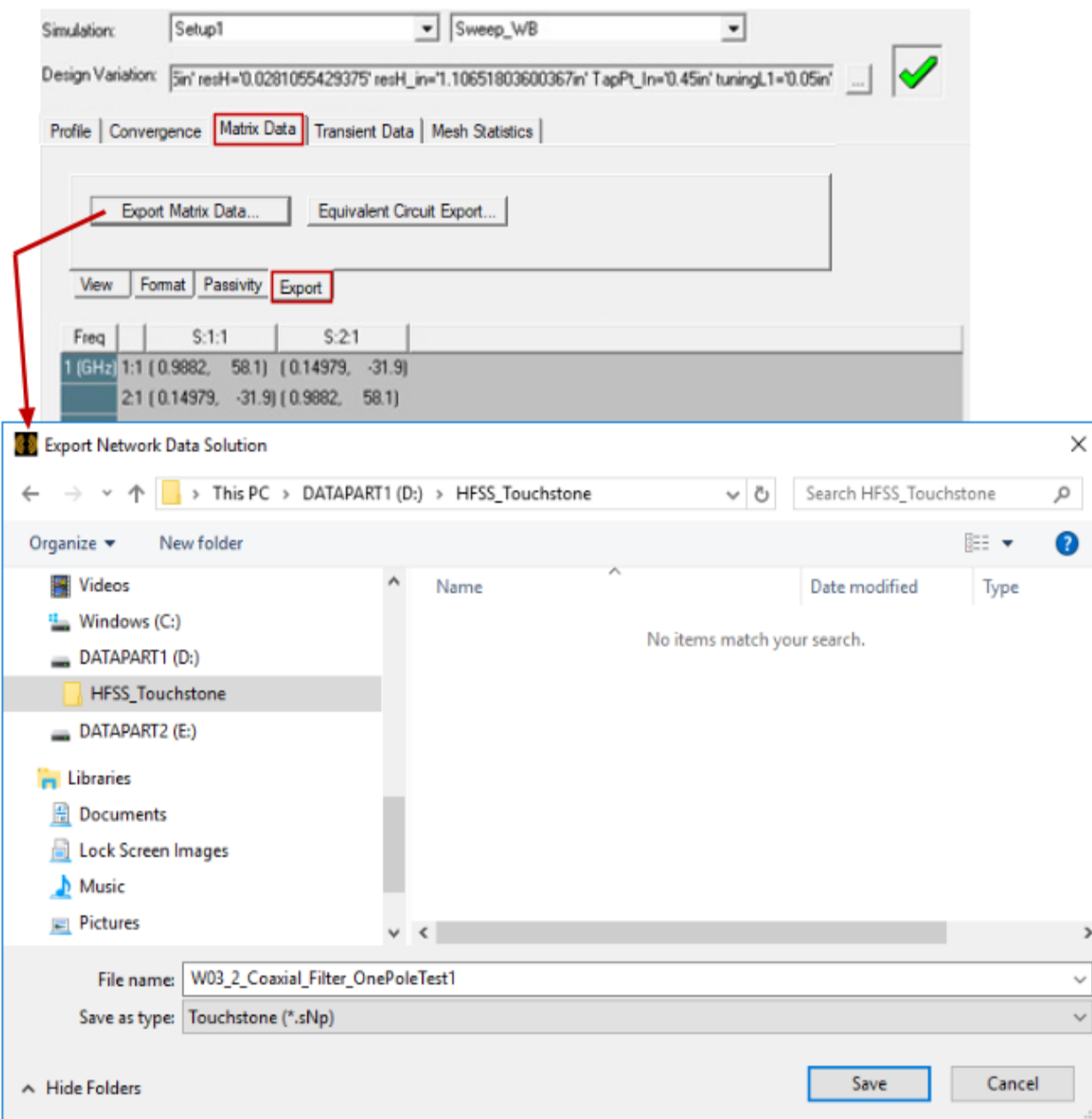

Figure 6-2 Exporting Touchstone Files

The steps for exporting matrix data in touchstone format is straightforward. Right-click **Results** from the **Project Manager** window and select **Solution Data** from the shortcut menu. This command opens the *Solution Data* window. Next, select the **Matrix Data** tab and the **Export** subtab. Finally, Click **Export Matrix Data**. This button lets you export the calculated quantities in touchstone format. Browse to your desired folder to save the file in touchstone format.

Advanced Plotting of Results

In addition to S-parameters, HFSS can plot a number of additional quantities of interest in RF/microwave/SI design using the Results Editor. A partial list of these quantities include gamma information, Y and Z parameters, TDR results, VSWR data, and Group Delay.

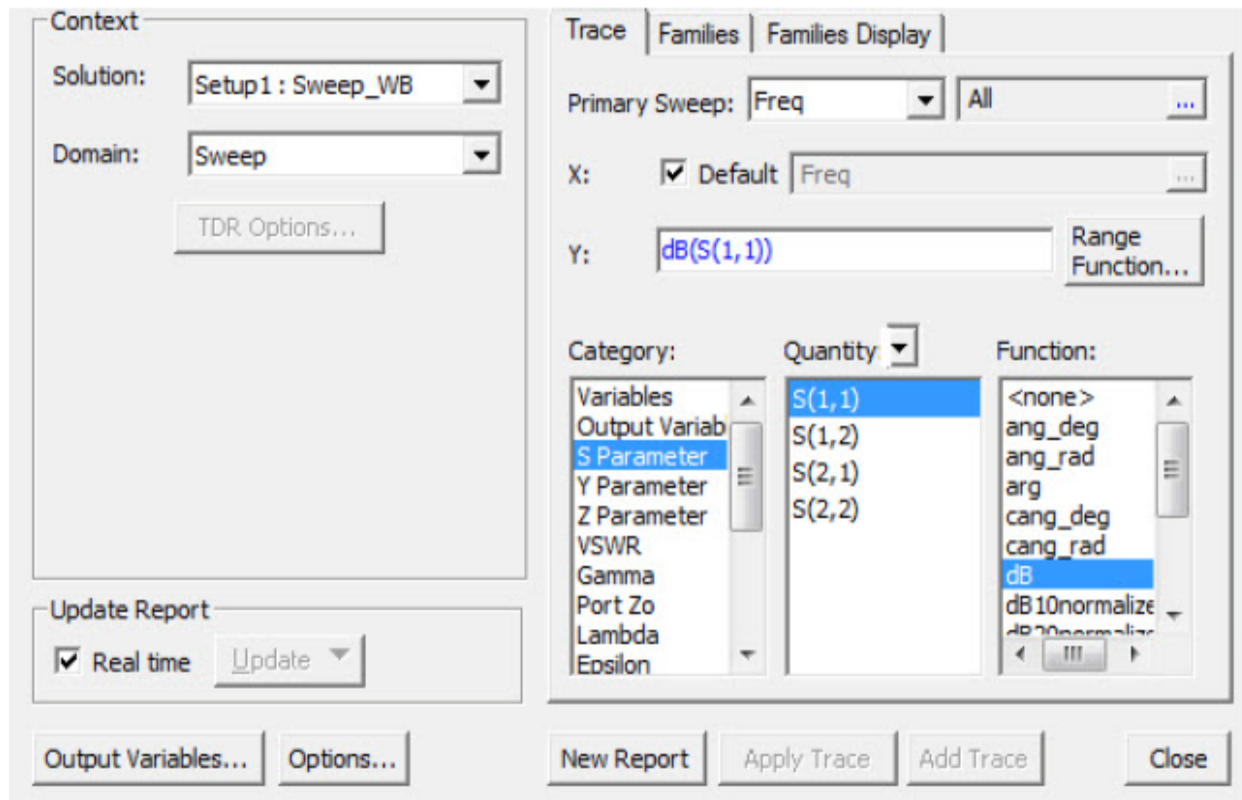

Figure 6-3 Report dialog box

Some of the options appearing on the **Results** dialog box are described below.

Domain: Plot time-domain responses for a given simulation model by selecting TIME as the sweep variable in the drop-down dialog in the upper left of the New Report dialog box. Once the TIME variable has been selected, the TDR options button becomes active and a user can choose to plot a time-based system response such as a TDR plot.

Families: For a parametric sweep, the data families are available to be plotted if you select the Families tab in the top center of the New Report dialog box. The Families tab allows you to access parametric data.

Output Variables: To generate mathematically based output quantities, select the **Output Variables** button. The standard output quantities can be enhanced by creating output variables

based on mathematical expressions. These output variables can be created by clicking on the Output Variables button in the lower right-hand corner of the New Report Dialog.

Category: Select the appropriate Category depending upon the quantity of interest that you want to plot.

Function: This option allows you to choose a proper function type for your quantity. For example, you can select dB for plotting S-parameters.

Note: Reports can also be generated by clicking HFSS in the menu bar, selecting results, and selecting create modal (or terminal) reports. In the new report dialog box, you can specify what data is to be plotted (as shown above).

Plotting Antenna Results

Far field antenna patterns are easily generated by HFSS using the **Reports** Editor. The procedure is similar to plotting the standard circuit parameters. But the model should include either Radiation or PML boundaries, and a Far Field Setup must be defined before Far Field quantities can be plotted.

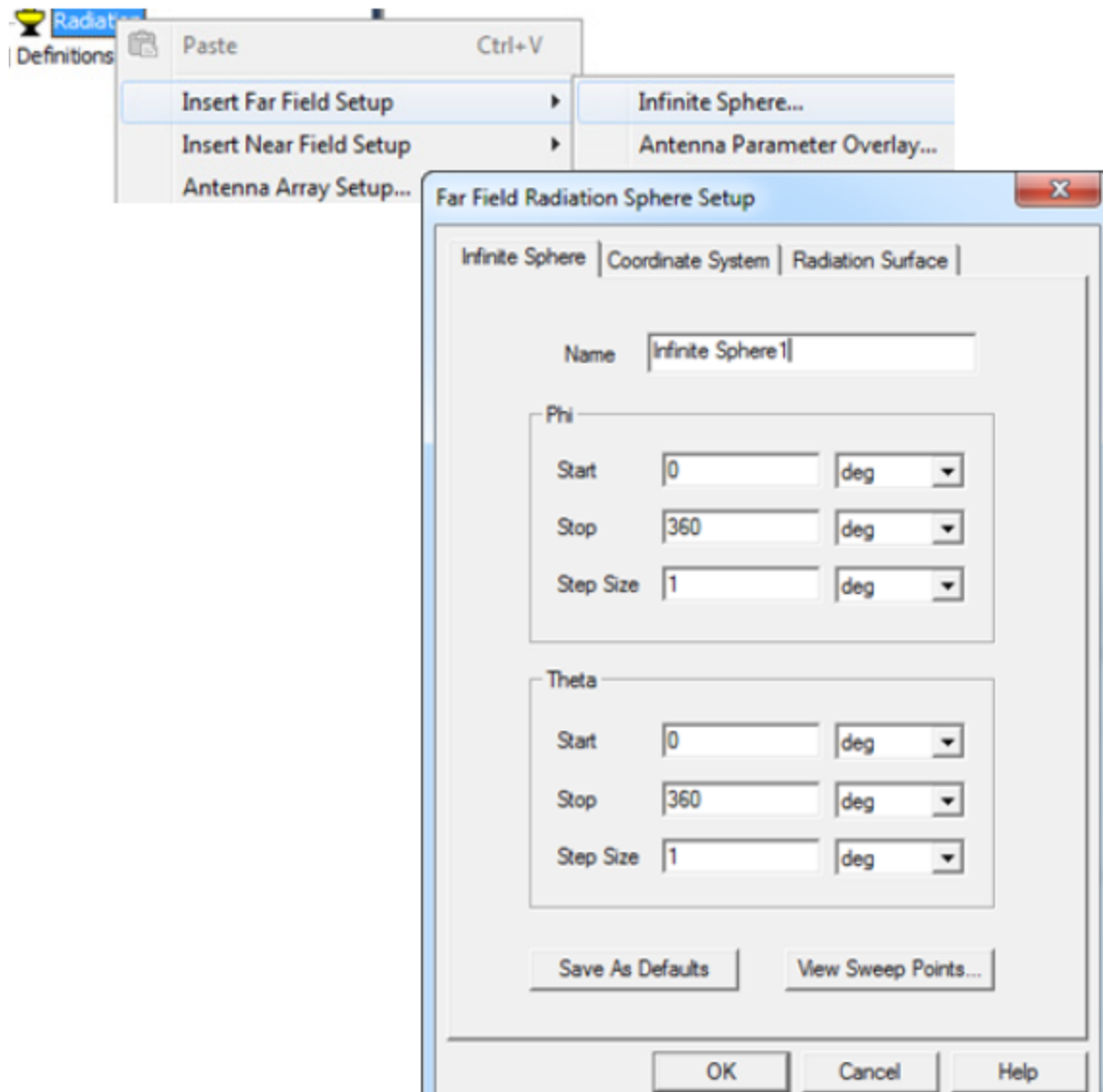

Figure 6-4 Far field radiation sphere setup

The specified far field radiation sphere setup is selected from the **Geometry** drop down menu of the **Report** dialog box. This report dialog box is generated by right-clicking **Results** in the **Project Manager** window and selecting **Create Far Fields Report > Radiation Pattern**.

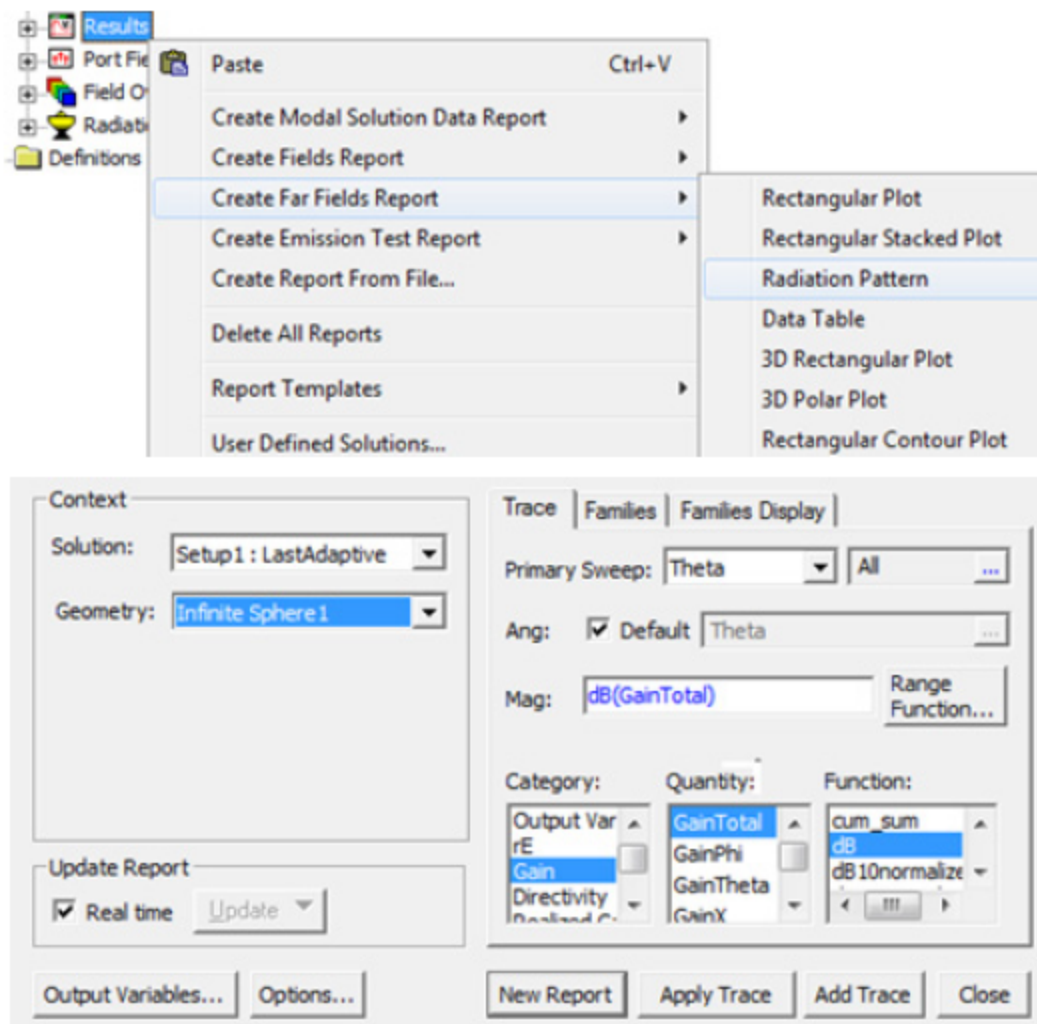

Figure 6-5 Creation of Far Fields Radiation pattern

When HFSS generates far field data, the field values on the radiation surfaces are used to compute the fields in the space surrounding the modeled structure, outside of the solution volume. This space is broken down into the near field and far field regions, where the near field is the region close to the solution volume.

Plotting Field Results

HFSS can produce a plot of any standard electromagnetic quantity, such as the electric field, magnetic field, Poynting vector, or current density. Generally, fields are displayed on 2D objects, faces of 3D objects, or on coordinate system planes. Plots can be scalar quantity plots or vector quantity plots.

Specific quantities based on mathematical operations on the basic field quantities can also be plotted by use of the fields calculator.

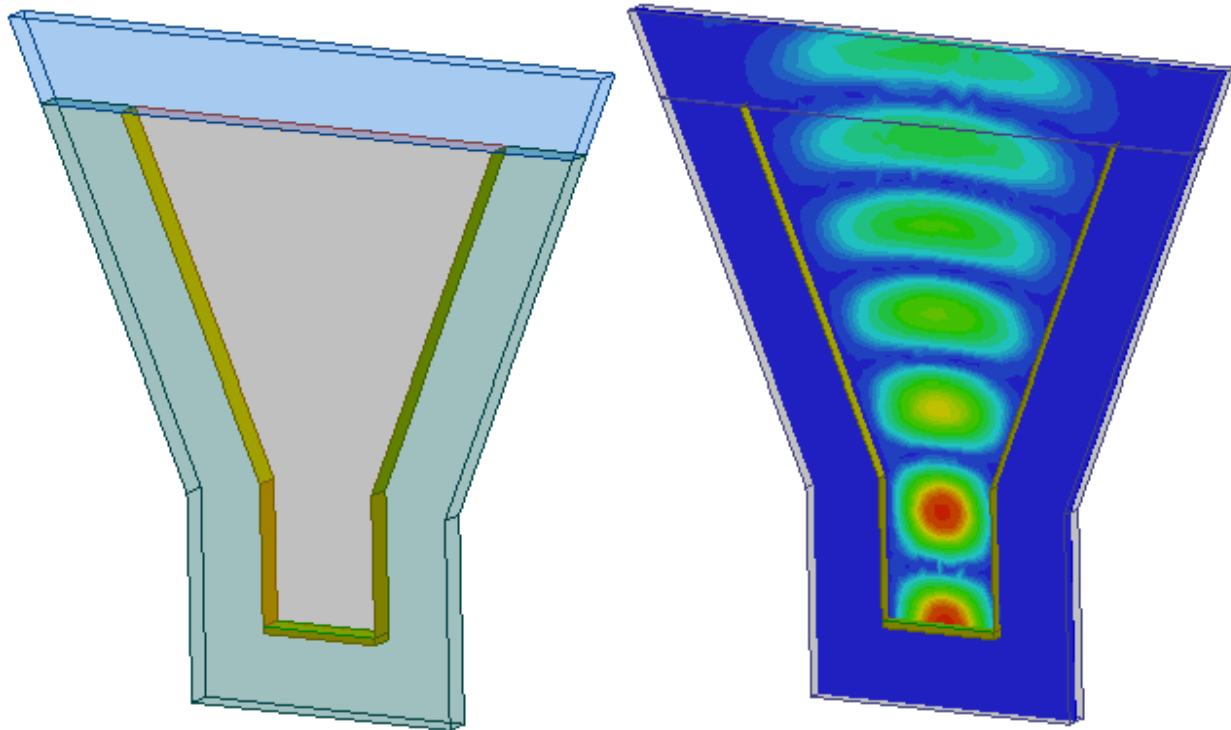

Figure 6-6 Example of an E-field plot on the XZ plane of a pillbox antenna

Field plots or, more specifically, field overlays, are representations of the basic or derived field quantities on specific surfaces of objects or within an object for the current design variation.

A field overlay's appearance can be changed by modifying the settings in the Plot attributes dialog box. This dialog modifies a plot folder and all field overlays contained within that folder will use the same attributes.

Field overlays can also be created by the use of the field calculator. The field calculator allows you to create mathematical operations on the basic field quantities. These results can be plotted or exported depending upon your needs. Once a mathematical operation has been created in the calculator, it can be added to the **Named Expressions** stack. After adding, this quantity can be plotted by selecting **Plot Fields > Named Expressions** dialog.

Alternatively, you can simply right-click in the modeler window, and select **Copy Image**. This operation places the contents of the window into the "clipboard," and you can paste the field overlay into a document such as Word or PowerPoint.

Creating Animations

HFSS allows the animation of any field overlay plot. Field overlays can be animated with respect to excitation phase or any other variable that is part of the HFSS design, including user-created variables.

Only existing field overlays can be animated.

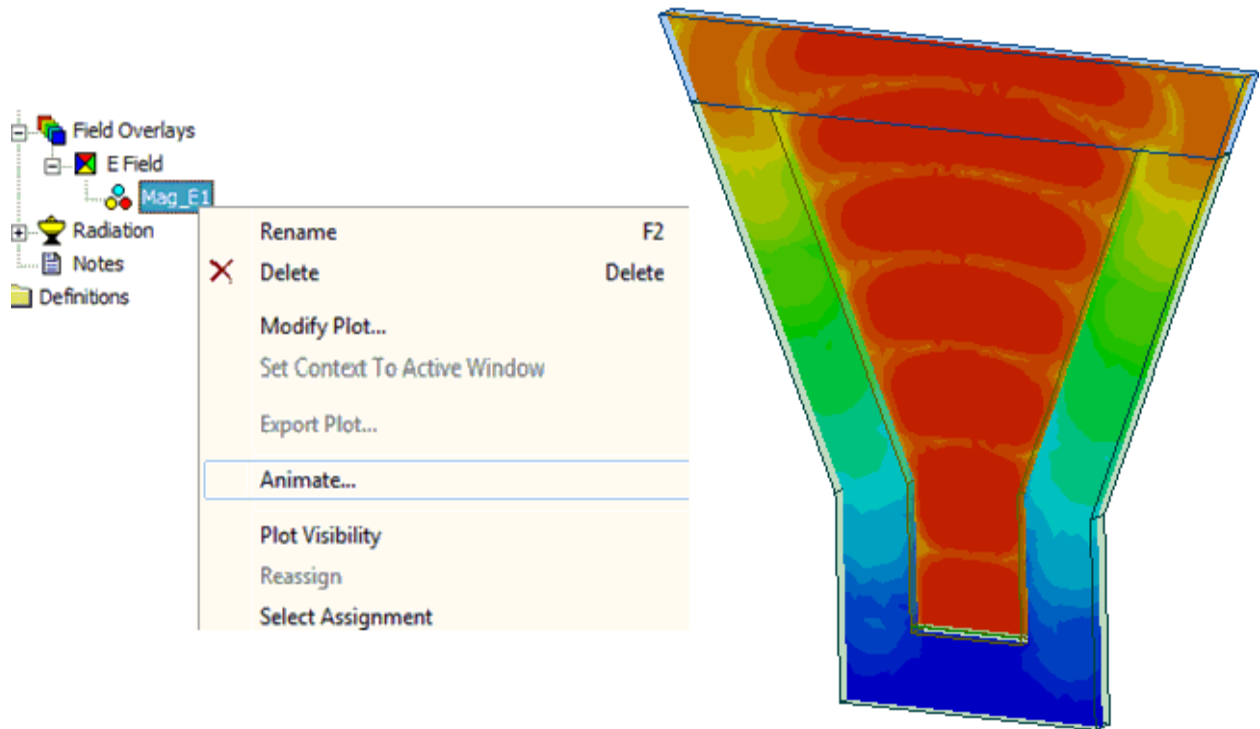

An animated plot is a series of frames that displays a field, mesh, or geometry at varying values. To create an animated plot, you can specify the values of the plot that you want to include. Each value is a frame in the animation. You can specify the number of frames to include in the animation.

7 - Component Modeling

- ["3D Components" below](#)
- ["3D Components Workflow" below](#)

3D Components

In HFSS, you can create 3-D components and integrate them into larger assemblies. HFSS 3-D components also comes with optional encryption and password protection features that allow component creators to control their access and use.

This 3D component modeling approach facilitates the creation of large communications systems, and becomes especially useful as these systems become more and more complex. Consider the creation of an aircraft communication system in which a number of blade antennas operate on a single helicopter. The component modeling approach enables the antenna engineer to create the blade antenna once and turn it into a 3D component. They can also create copies of this component in order to make them shareable with the system integrator. For the system integrator it is very efficient and convenient if these blade antennas exist as 3D components so that they can simply add these simulation-ready components onto the helicopter body. If the creator of the antenna chose to protect their model by encryption, a password or an internal key is needed; when the blade antennas are placed on the body of the helicopter the end user needs the password or the internal key to place the component on the model and run the simulation.

This results in an accurate, fully coupled 3-D simulation that accurately characterizes the antenna performance in the context of the entire communication system.

This component design flow saves time and effort since you only need to create a component once, and then can make it available for use while designing several different communication systems. It also enhances collaboration among engineers and allows each to focus on their area of expertise thereby improving workforce productivity.

Simulation-ready 3-D components can be created and stored in library files that can be simply added to larger system designs without the need to apply excitations, boundary conditions and material properties. All these internal details are already incorporated in the original design of the 3-D components.

3D Components Workflow

This section describes the typical workflow involved in creating a 3D Component, hiding the internal details of the component, encrypting the component and then adding it to a target design. To illustrate the workflow, a blade antenna design is used. The blade antenna is turned into a 3D component and placed on the top of a helicopter model. The process of creating the 3D component and integrating it to a larger assembly is described below.

- Press the **O** key to enter object selection mode in HFSS, and select the entire antenna.
- Right-click and select the **Create 3D Component** option from the sub-menu. This command brings up the **Create 3D Component** dialog box which contains the following tabs: **Info**, **Model**, **Boundaries**, **Excitations**, **Mesh Operations**, **Coordinate Systems**, **Parameters**, **Encryption**, **Hybrid Regions**, and **Image**.
- The **Info** tab is populated with the default component name (in this case, **Blade Antenna**), its owner, date, and other details. The fields appearing on the **Info** tab are editable. You can enter text in the **Notes** field if needed; if you want you can also enter your organization's name in the **Company** field.
- If you want to display your company logo when the component is used, select the check box **Display image in 3D modeler window whenever this component is used**, and click the **Browse** button to locate the appropriate graphic and include it.
- All properties of the blade antenna are encapsulated in the component. The properties on the various tabs cannot be modified directly in the target design. However, you can define parameters in the component. The user of the component can modify these parameters in the target design. If the creator of the component edits its properties and saves the changes, the user of the component has the option to update the instance in the target design.
- The **Image** tab gives the preview of the 3D component that the user will see when selecting the component.
- 3D components also come with the encryption and password protection features that allow the user of the component to control their access and use. These features are optional.

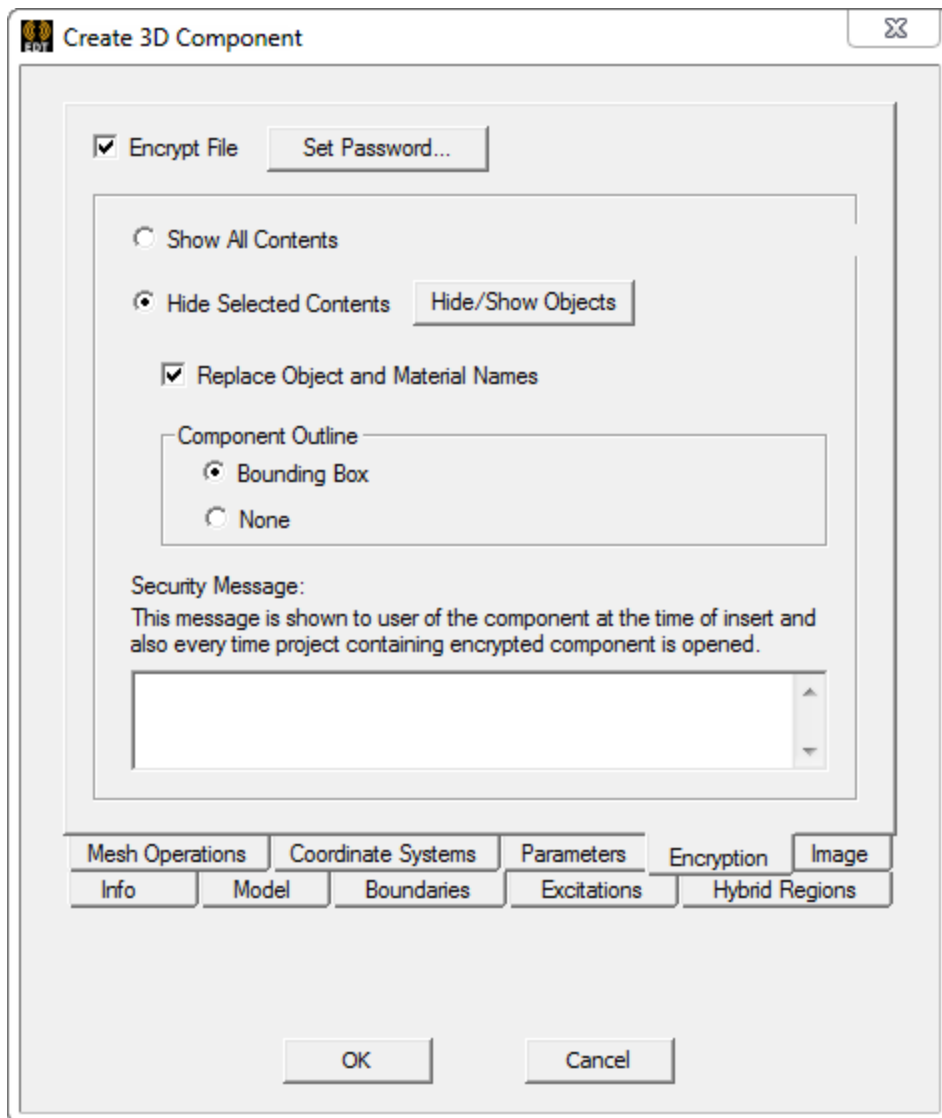

Figure 7-1 Encryption tab of the Create 3D Component dialog box

- Another important feature is that the creator of the component can also hide its internal details. By default all objects of the 3D component are hidden. You can select the objects that you want to hide from the user of the component. Depending upon your preference you can also make all or some of the objects in the component visible. For example, you can make the component outline visible along with some geometry details to help the user of the component with its placement and the post processing operations. The objects that you want to hide or make visible in the target design can be specified in the **Model** tab.
- To encrypt the component you can configure a user password or an internal key.

- After you specify the various options accordingly on the **Create 3D Component** dialog box, clicking **OK** brings up the **Export File** window.
- You can store the component in any location. UserLib or PersonalLib directories are also provided for storing the components. The *first* 3D Component that you save in one of these directories generates a folder named 3D Component under that directory. These UserLib and PersonalLib locations are for any libraries of definitions including materials, circuit components, and 3D components. Their usage is based on convention. Userlib is a central library in the installation directory that is meant to be shared by multiple users whereas Personalib, located in the project directory, is meant to be used by individual users. For this example, store the component in the UserLib so that the blade antenna can be shared with many users.

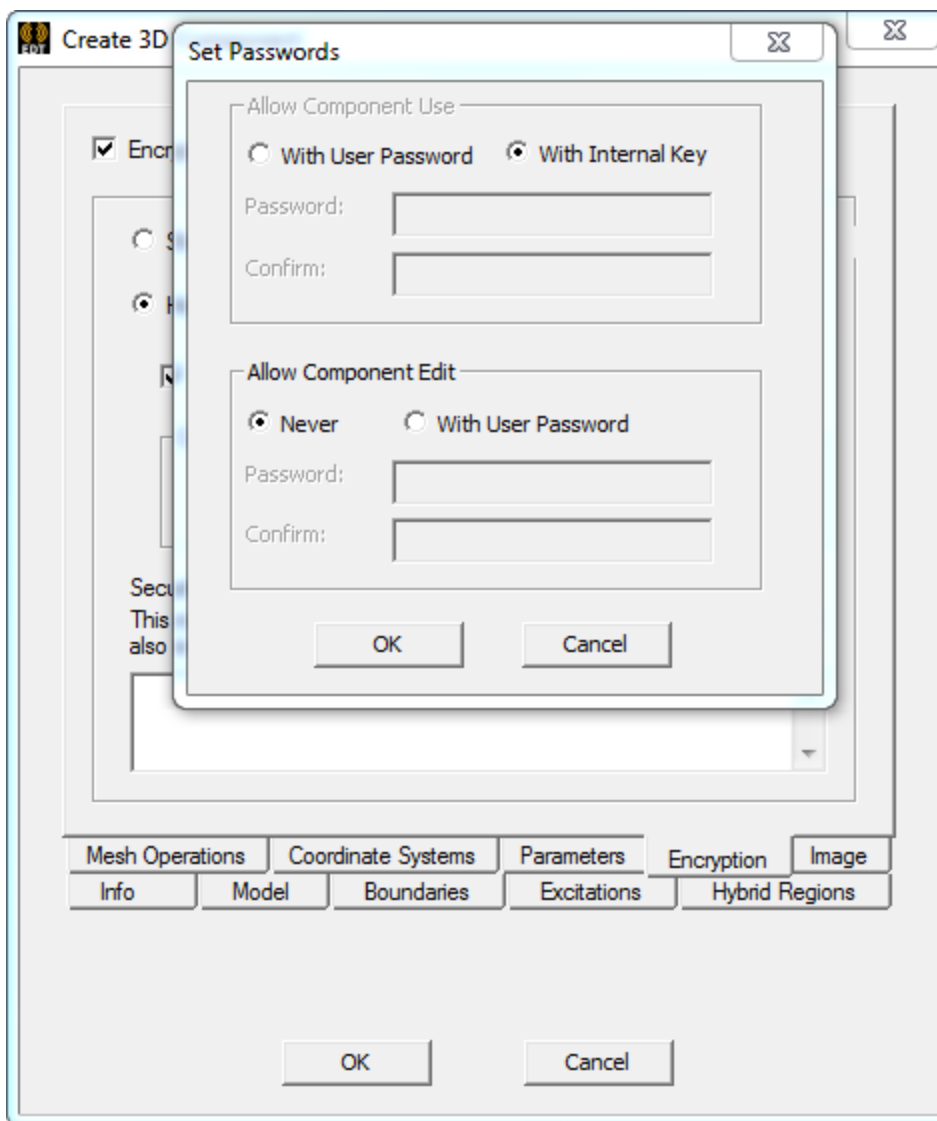

Figure 7-2 Encrypt the component by configuring a password or internal key

- At this point the 3D component with hidden content is created and becomes shareable with the user or the system integrator who can add the component to the target design.
- To add the component, right-click **3D Components** option on the Project Tree and from the sub-menus select **Insert Instance > UserLib > Blade Antenna**. Since the component is stored in UserLib, it appears as a selection.

Note: **Blade Antenna** is the default component name.

- If the 3D component was encrypted, an internal key or user password is required depending upon the type of protection configured by the creator.
- The **Insert 3D Component** dialog box appears. The **Image** tab accordingly hides the internal details as specified by the creator of the component. If you define the correct coordinate system for the placement of the component on the platform and click **OK**, the 3D component is added to the target design at the appropriate location.
- In this example, the blade antenna component gets placed on the top of the helicopter body.
- The system is now ready for simulation. The antenna details remain encapsulated in the 3D component and do not become a part of the helicopter model, but they are passed to the solver for simulation. This results in an accurate, fully coupled, 3D simulation of the entire system. Fields from the antenna induce currents on the helicopter body, and reflected fields from the helicopter may also interfere with the antenna performance. HFSS uses efficient hybrid simulation techniques to efficiently model the interaction between the structures, and to apply the appropriate solution methods to each.



3d component of a blade antenna that is integrated into a large assembly, in this case, a helicopter.

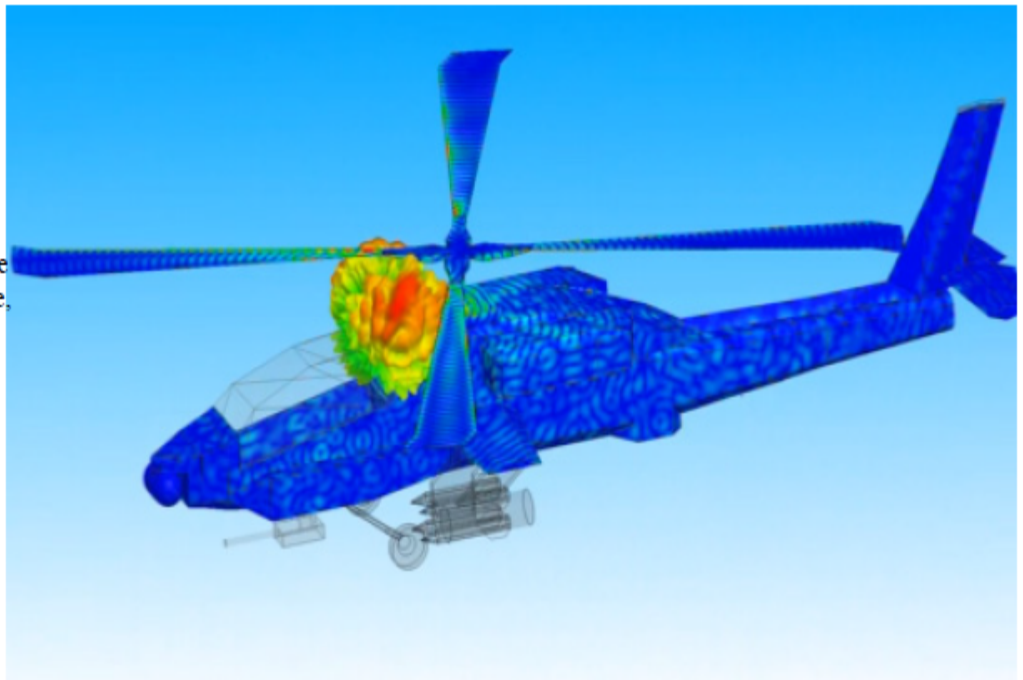

Figure 7-3 3D simulation of the entire system after Blade Antenna 3D component is added on the top of a helicopter body